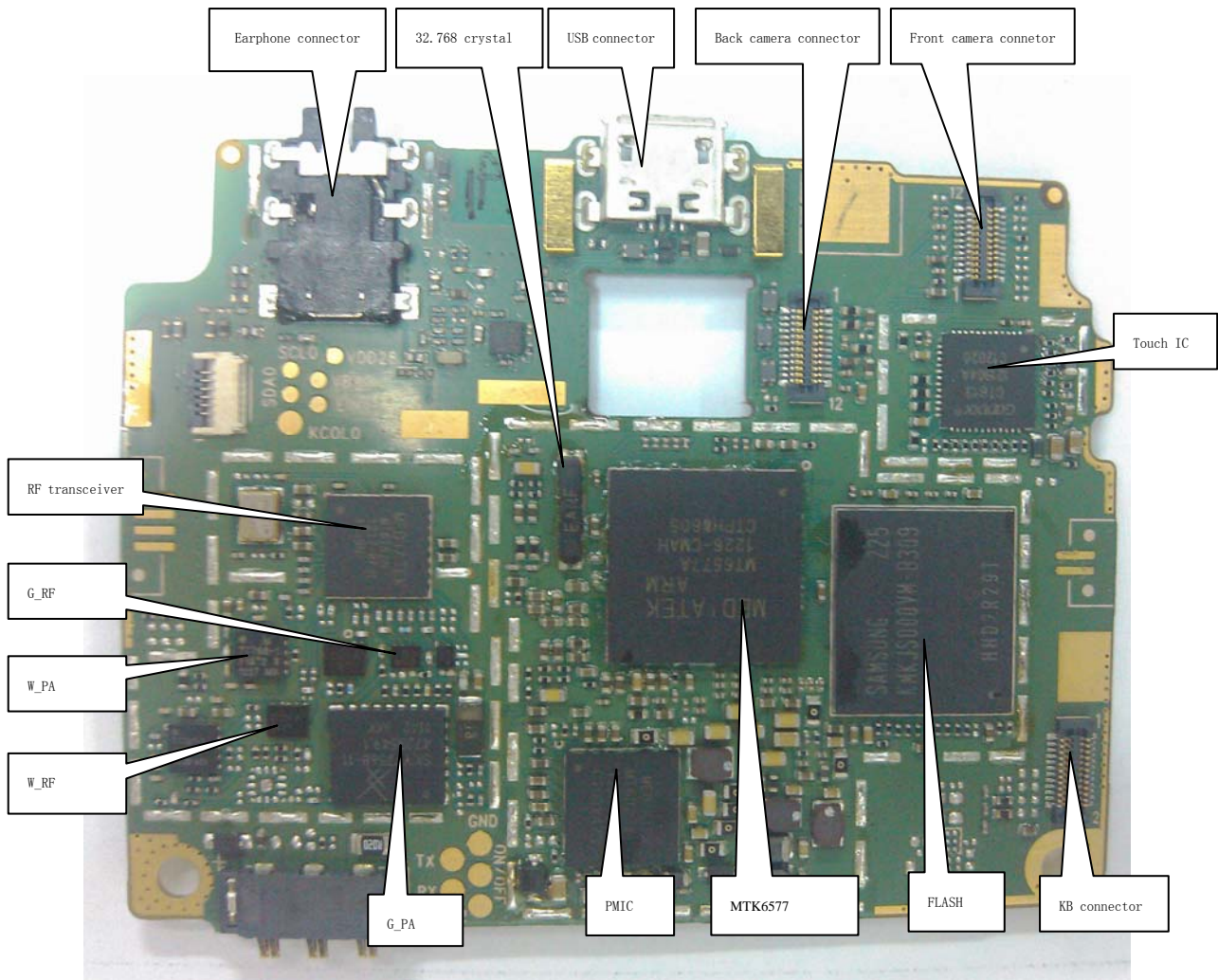

PAP5000 Maintenance Manual

Table of Contents

1. Circuit diagram instruction	3
1.1 Main board explored view	3
1.2 Detailed Description of Circuit Chart.....	5
1.3 Base band circuit.....	5
1.4 Function circuit	6
2. Fault maintenance	8
2.1 fault repair	9
3 Trouble shooting and flow chart	13
3.1 Unable to power on the handset.....	13
3.2 No ring tone	14
3.3 LCD display fault.....	15
3.4 Charging fault	16
3.5 Camera fault.....	17
3.6 Fail to identify SIM card.....	18
3.7 MIC fault.....	19
3.8 Keypad fault.....	20
3.9 Receiver fault.....	21
3.10 Vibrate fault	22
3.11 FM fault.....	23
3.12 No signal	24
3.13 Failure to identify T-flash card	25
3.14 Earphone fault.....	26
3.15 Unable to use USB.....	27

1. Circuit diagram instruction

1.1 Main board explored view



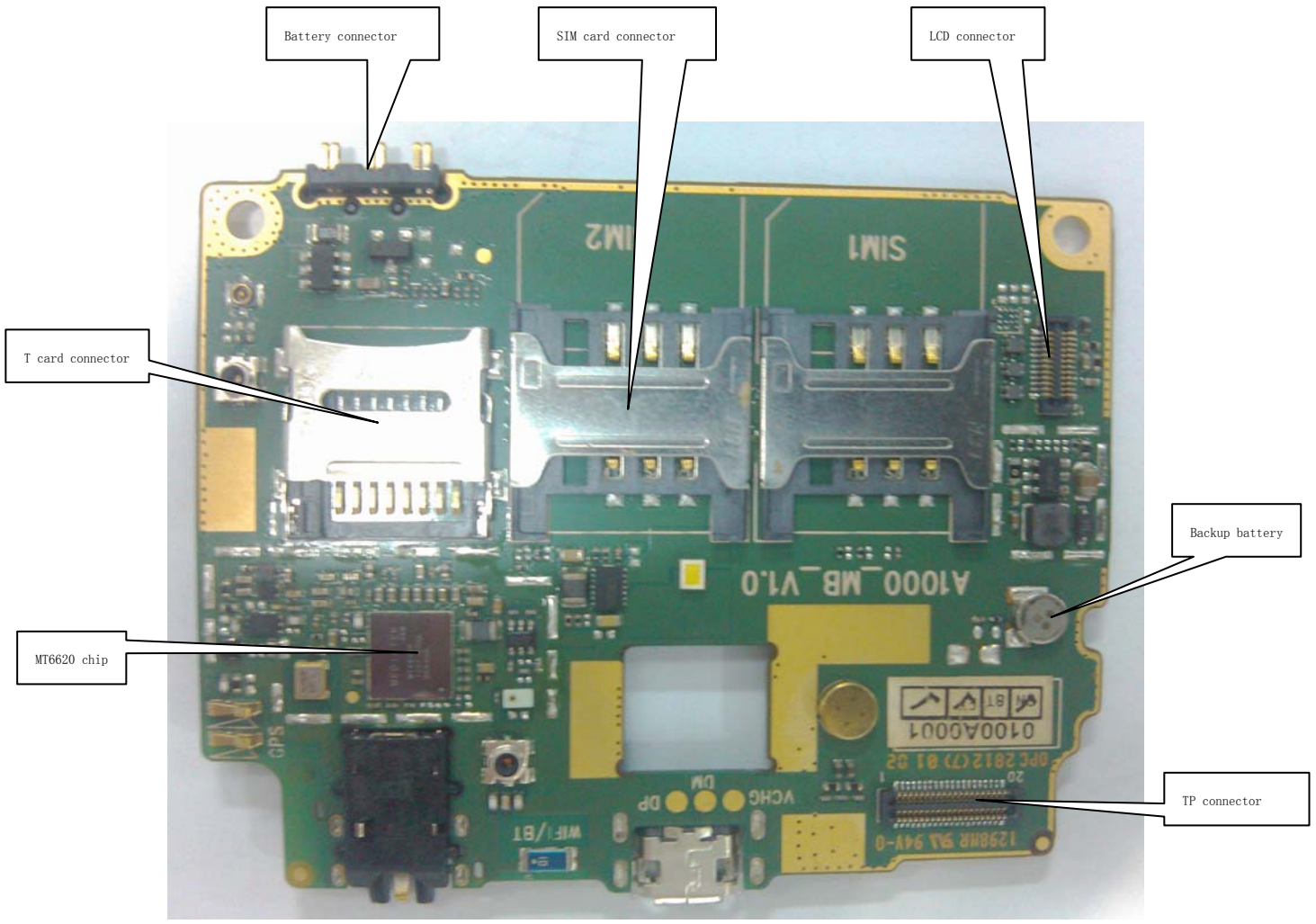

1.2 Detailed Description of Circuit Chart

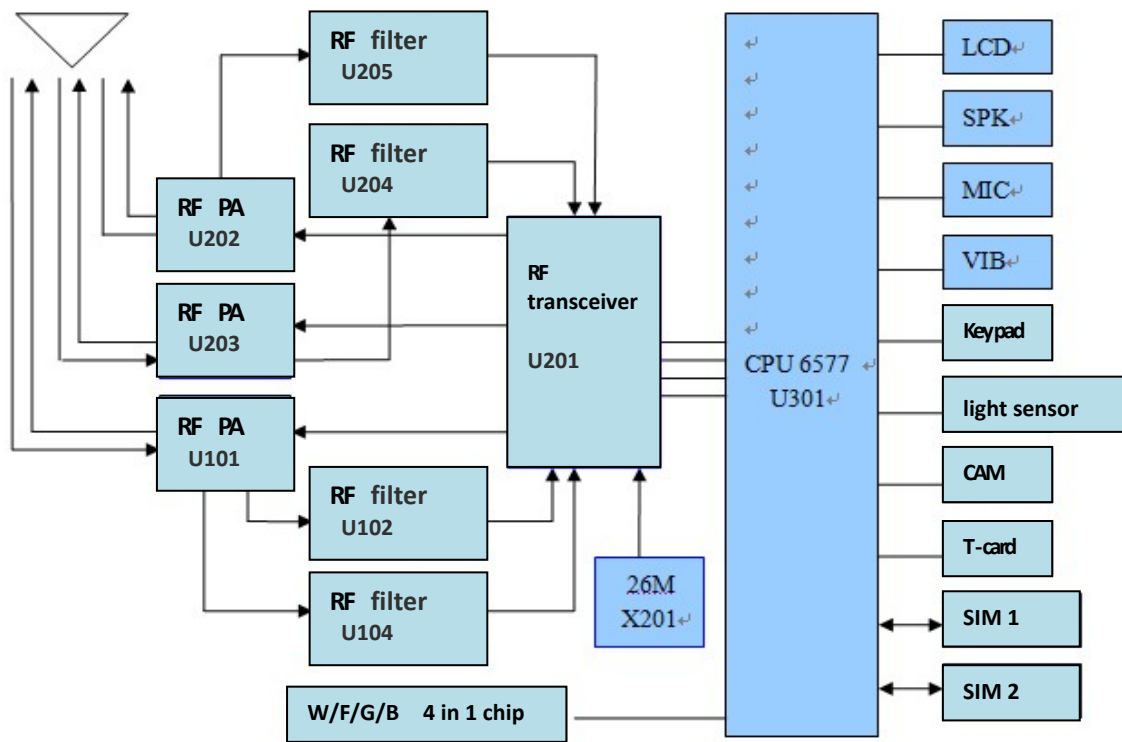

1.3 Base band circuit

Base Band adopts MT6577

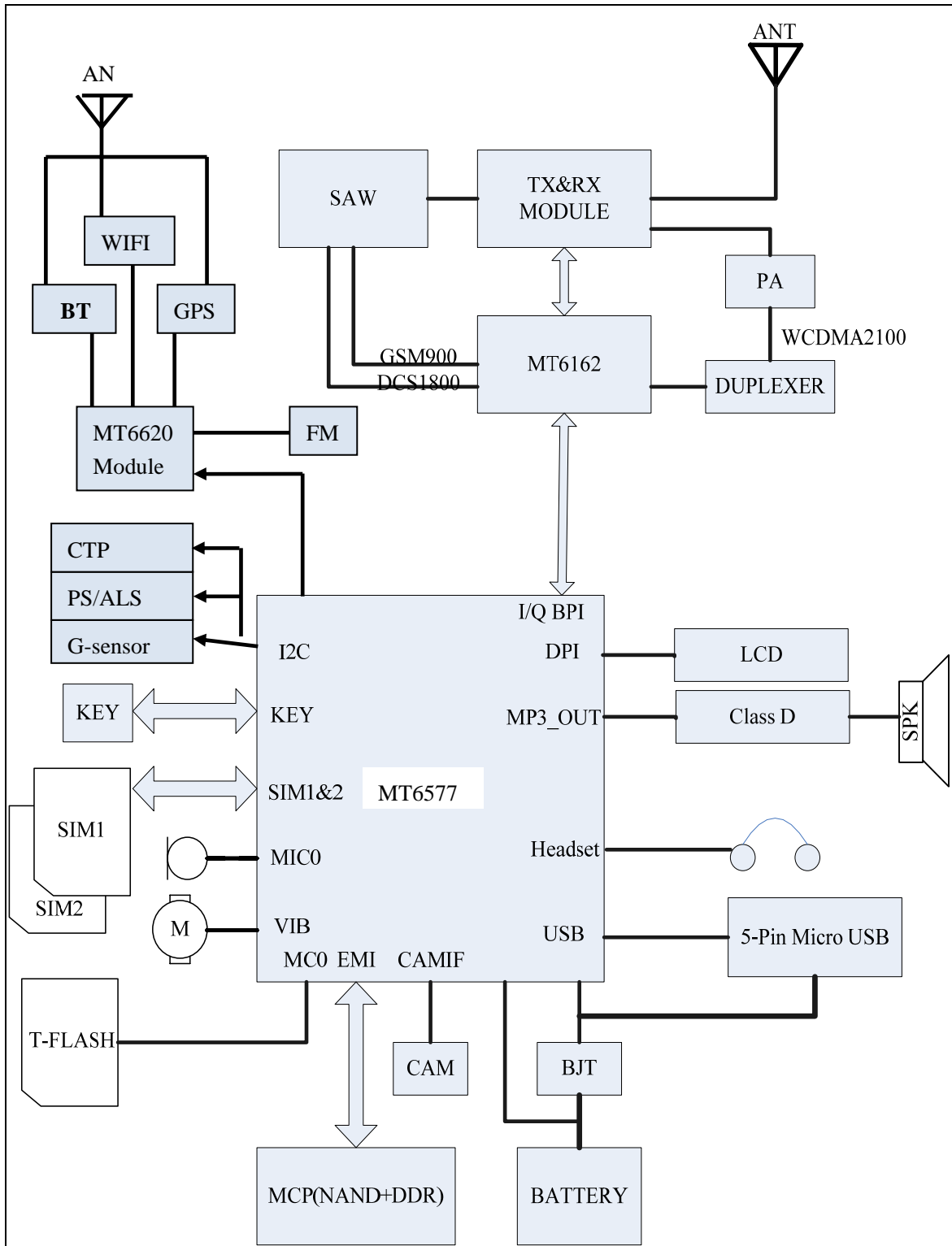

MT6577 internal schematic block diagram

1.4 Function circuit

GPS、WIFI、BT、 FM circuit:

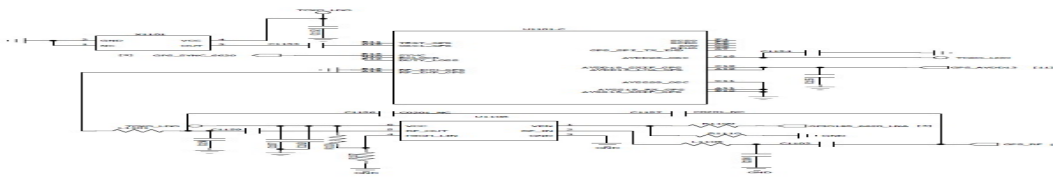
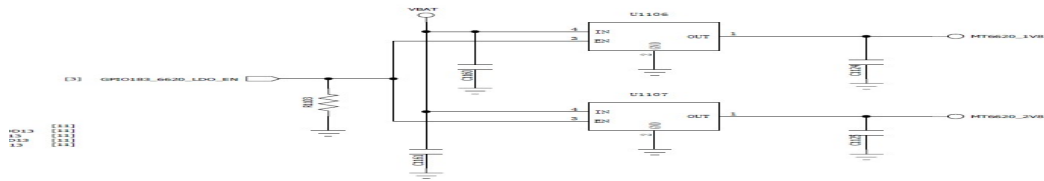
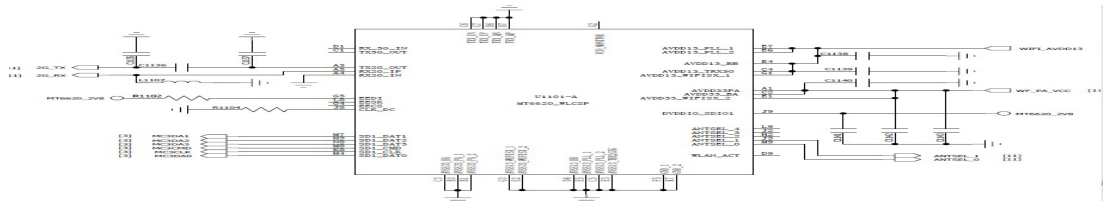

Dual SIM circuit:

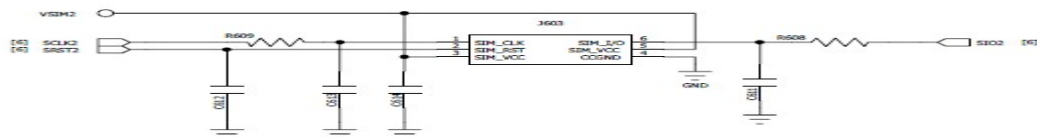

T-Flash Card circuit



CAM

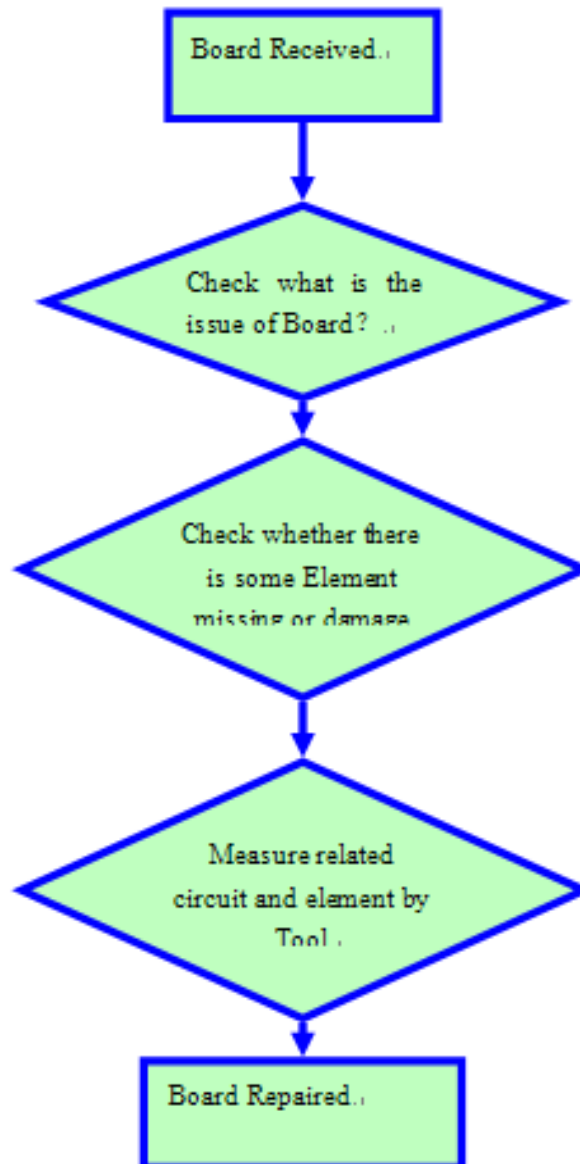
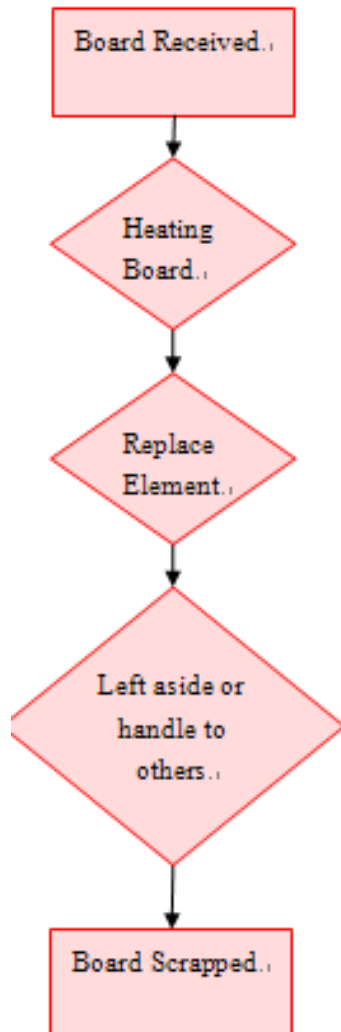

2.1 fault repair

Base band

MTK uses relatively high integration and has limited peripheral independent elements. Check whether there is any additional element, missing or wrong element before hot air gun is used. If visual detection fails to find problem, use some equipments to find failure positions.

(1) Below 20MA: indicates that power starts working but the next action is not performed. The cause can be incomplete soldering or damage in power management, CPU or 26M circuit.

(2) 20~25MA: the cause can be: there is no download software; software functions abnormally; or, CPU cannot read or execute software normally.

(3) 30~90mA: if the software, 26M and 32K are all normal, the cause can be incomplete soldering.

Check CPU and Flash

Startup process:

When the Power-On button is pressed, PWRKEY will detect a low voltage. The internal PMIC will turn on the LDOs which provide power-supply to base band 30ms later; then the RESET circuit of the PMIC will generate the reset signal 200ms later to make the base band chip run the power-on software

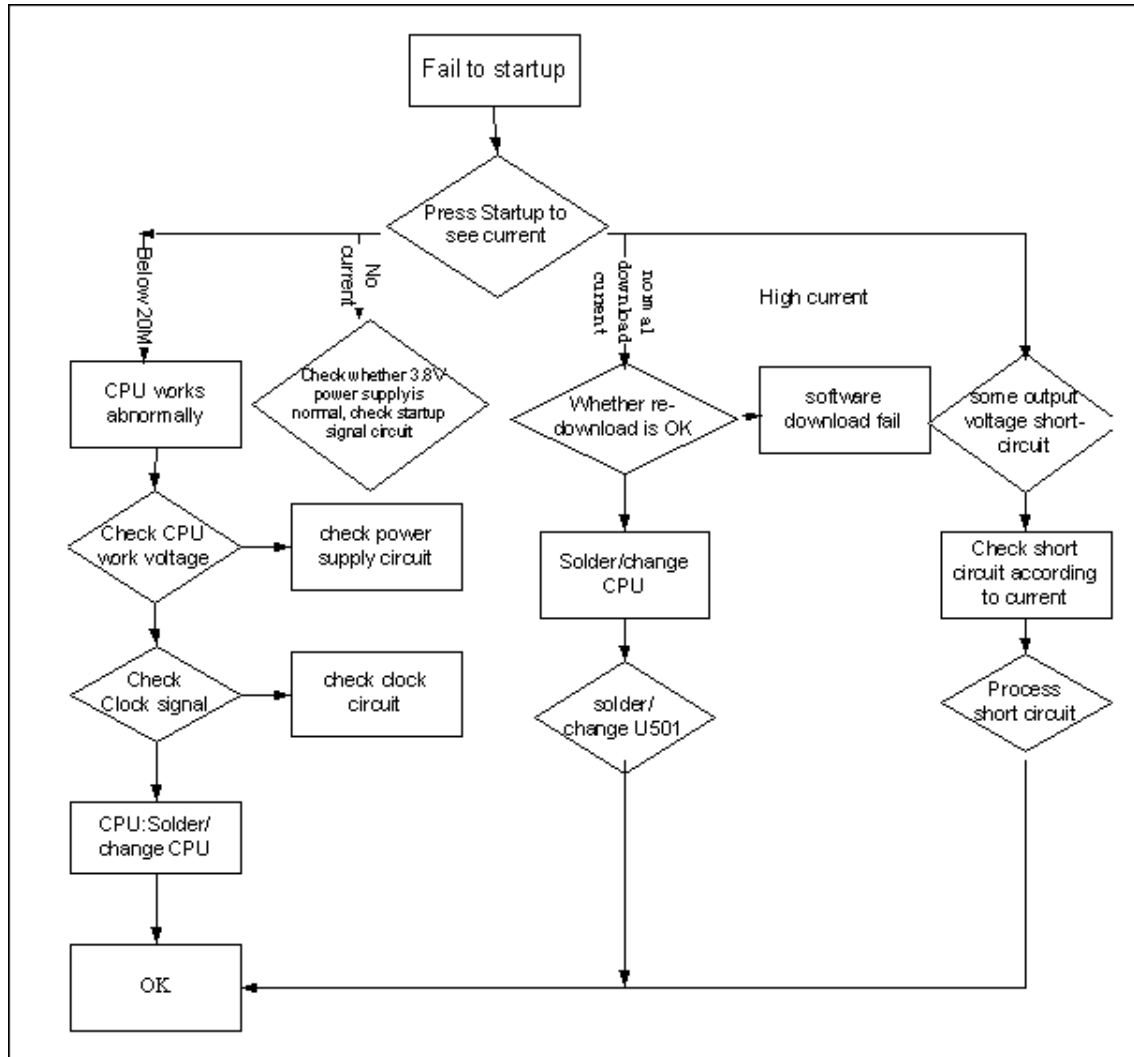

Fail to download

Make sure that the download current of main board is normal and important I/O interfaces including U301/CPU and U601/Flash are normal.

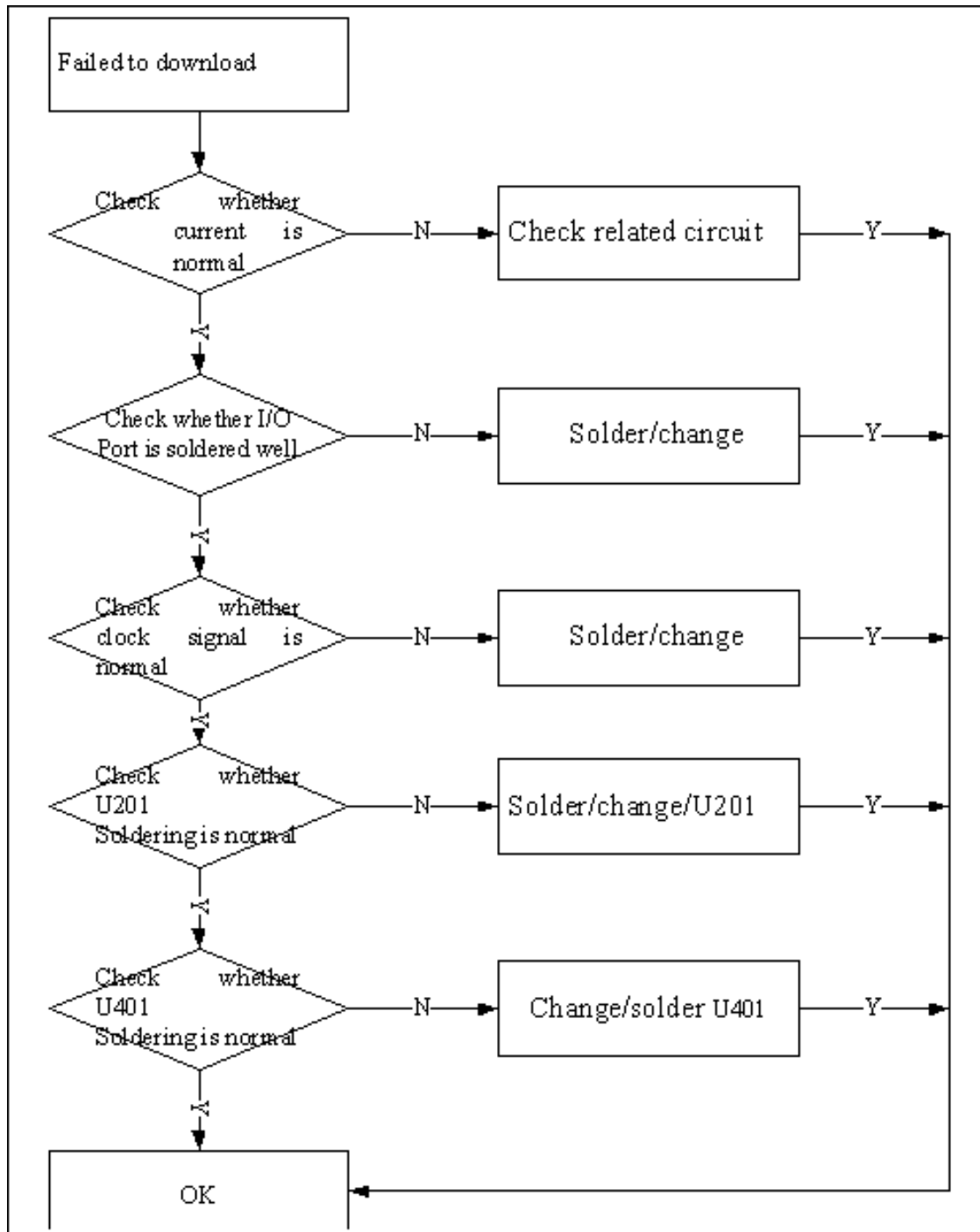

Bluetooth failure

Please refer to the details of Bluetooth circuit description in Part 1. First perform visual examination to check whether there are missing pieces on related circuits or significant deviation. Then perform circuit analysis according to the maintenance process.

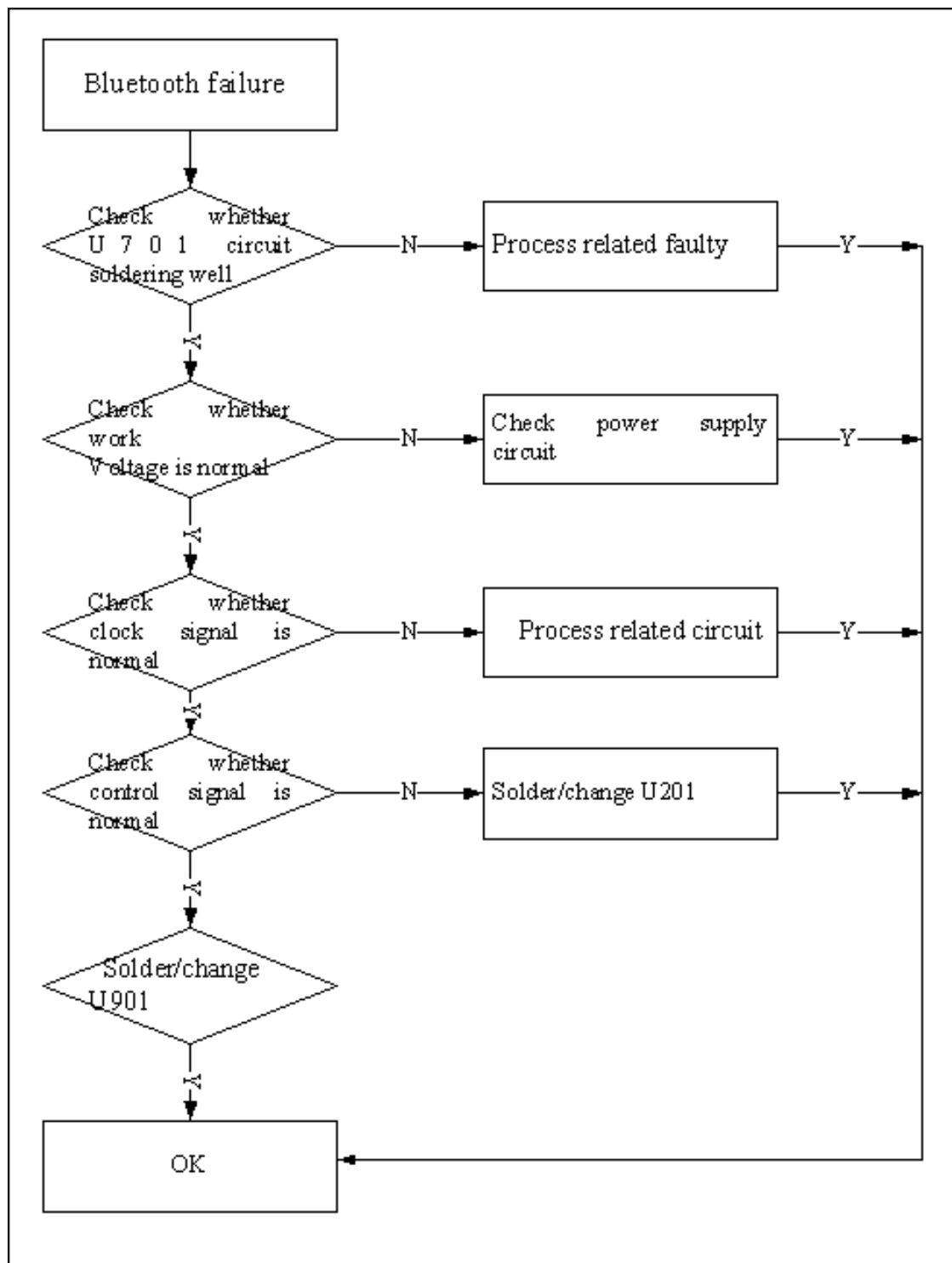

3 Trouble shooting and flow chart

3.1 Unable to power on the handset

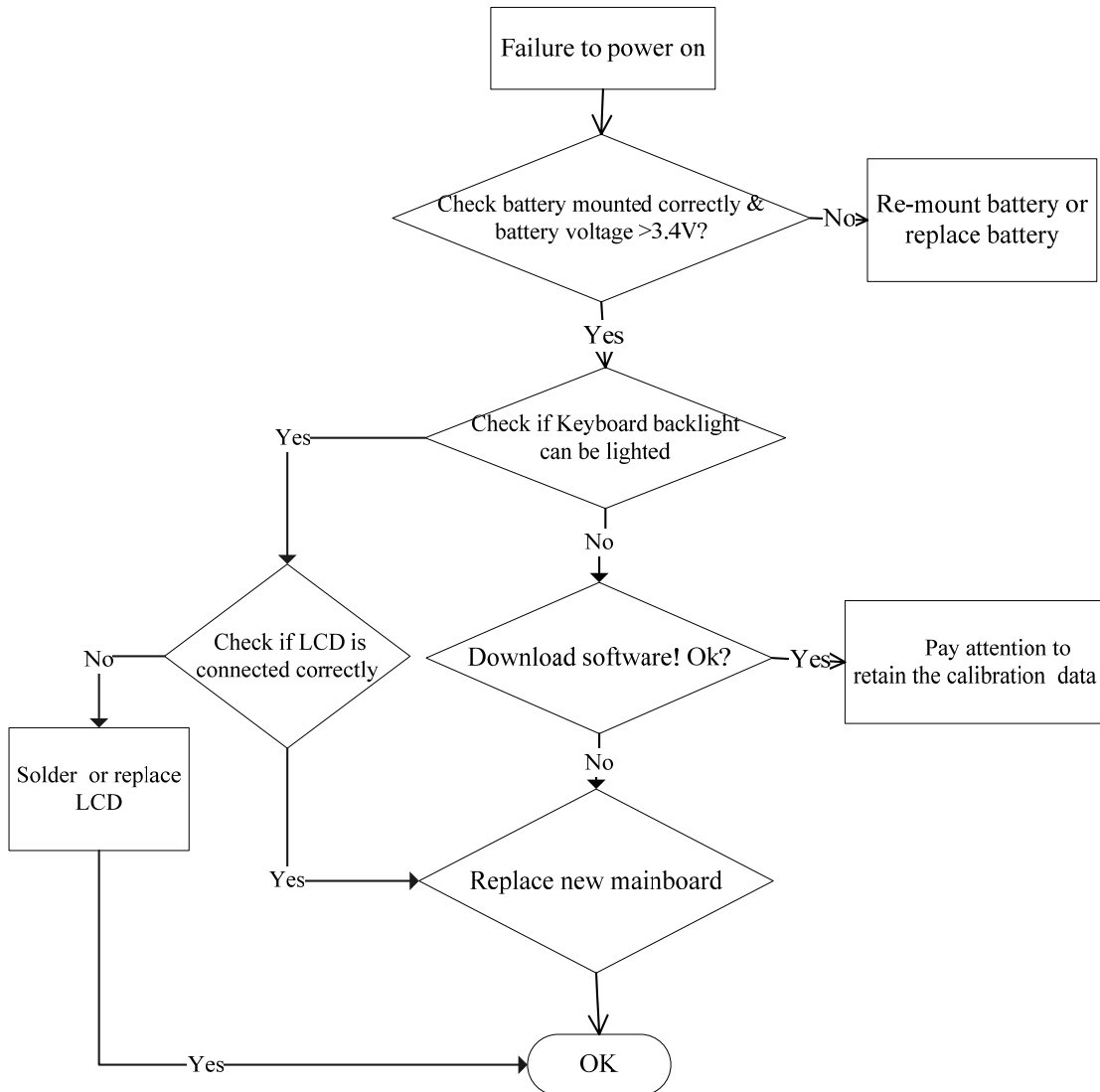

3.2 No ring tone

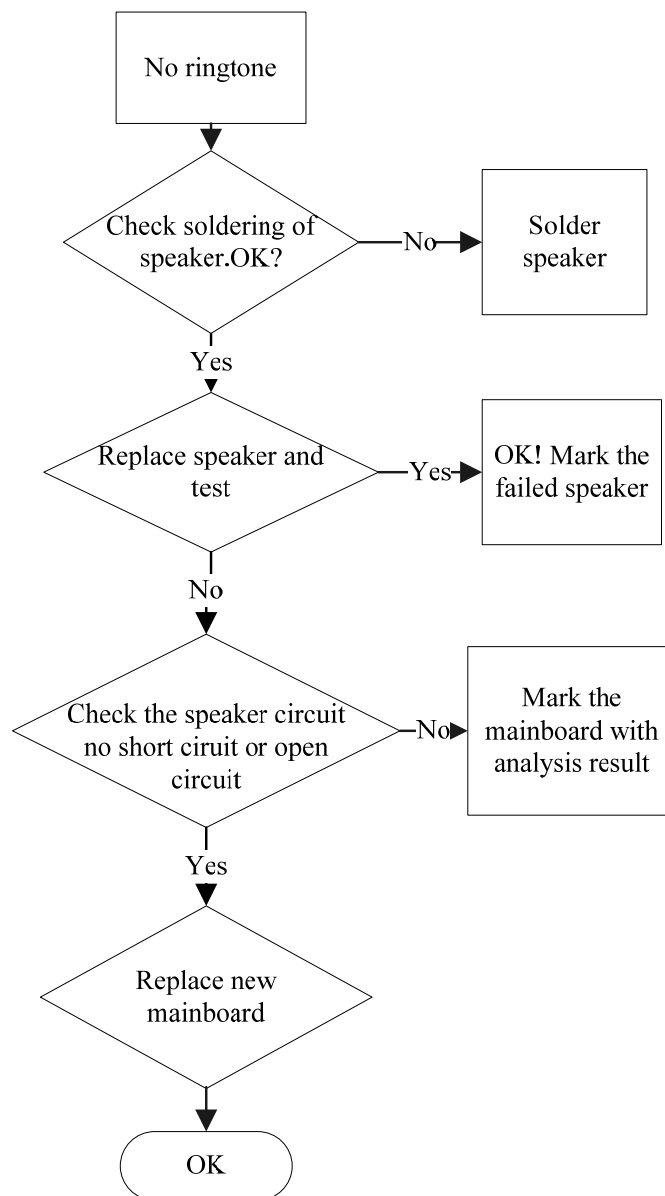

3.3 LCD display fault

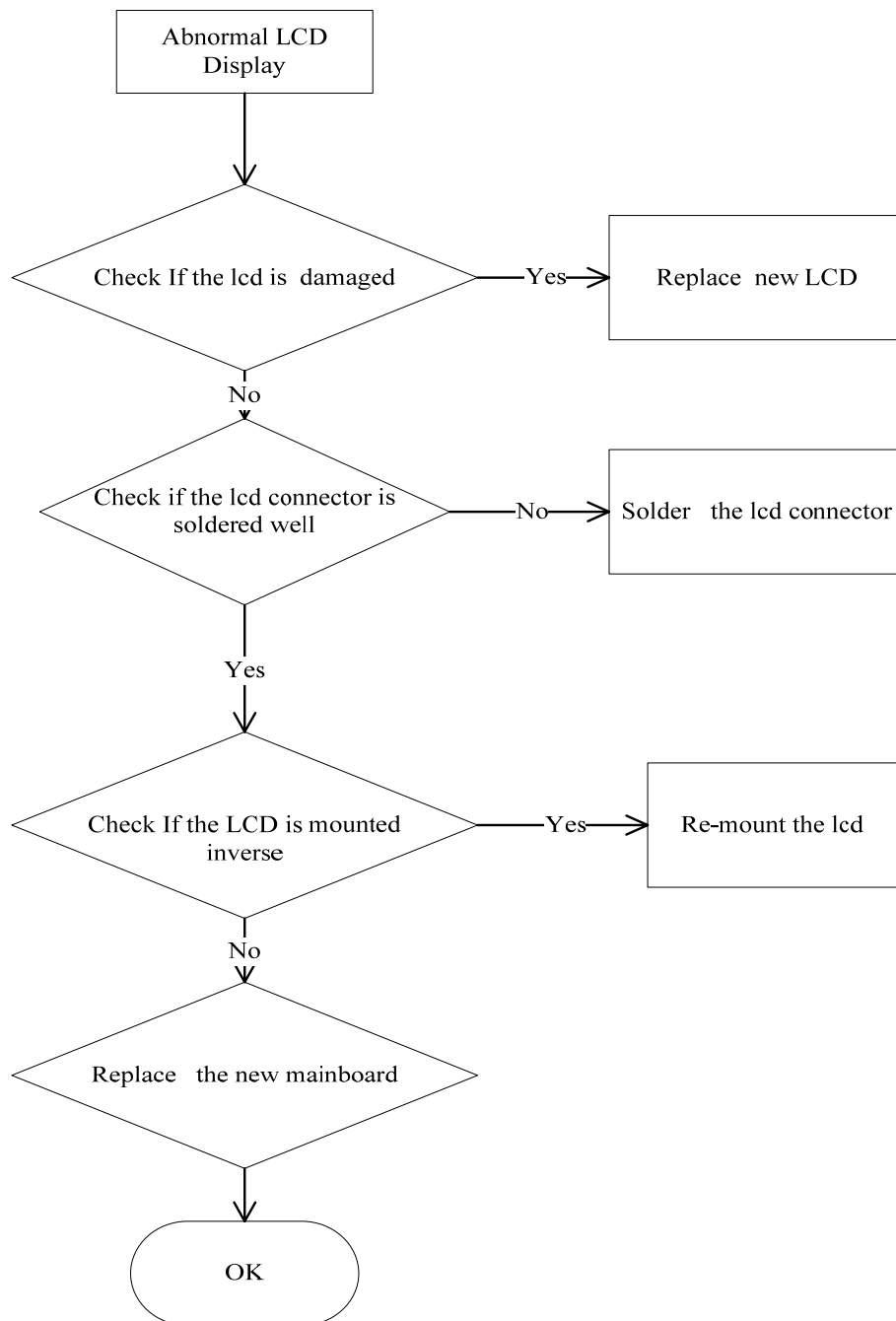

3.4 Charging fault

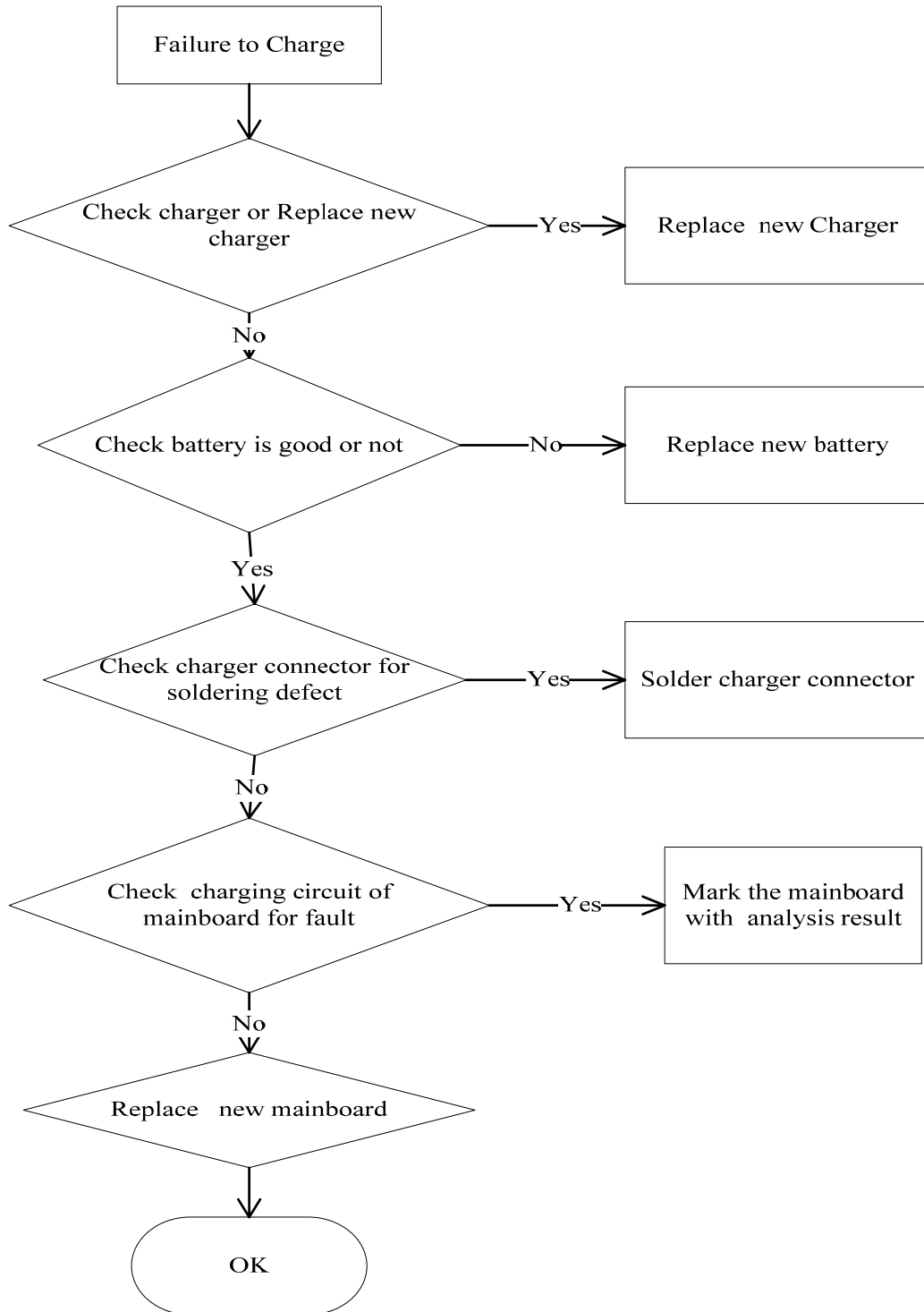

3.5 Camera fault

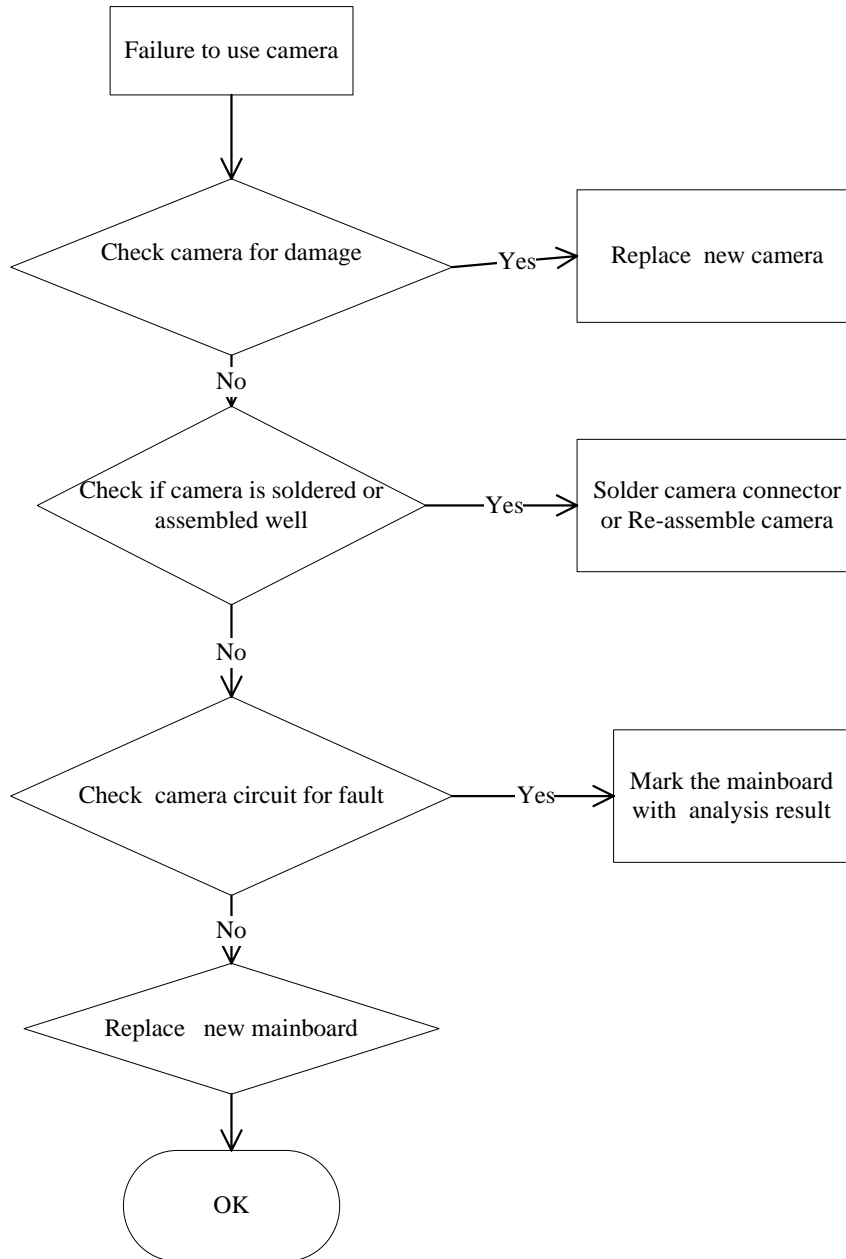

3.6 Fail to identify SIM card

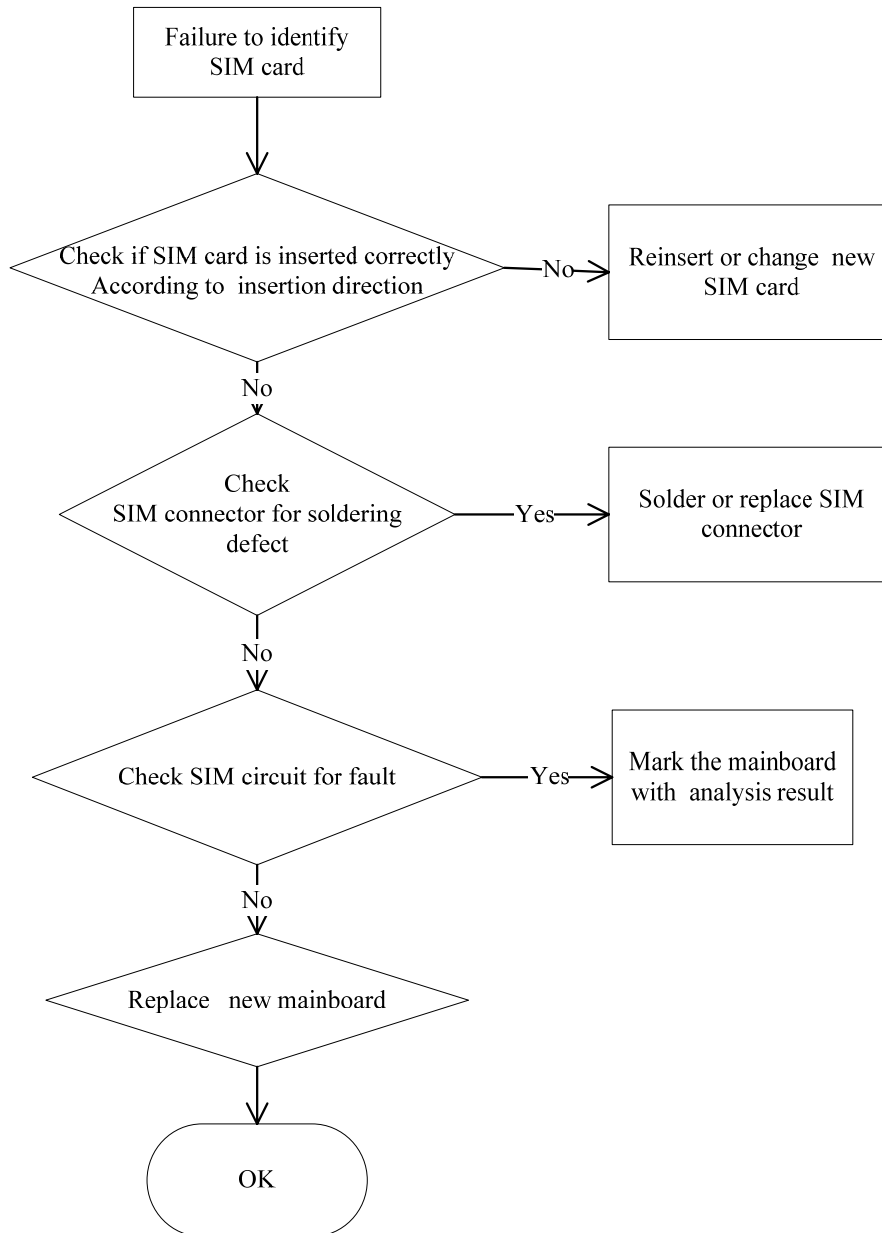

3.7 MIC fault

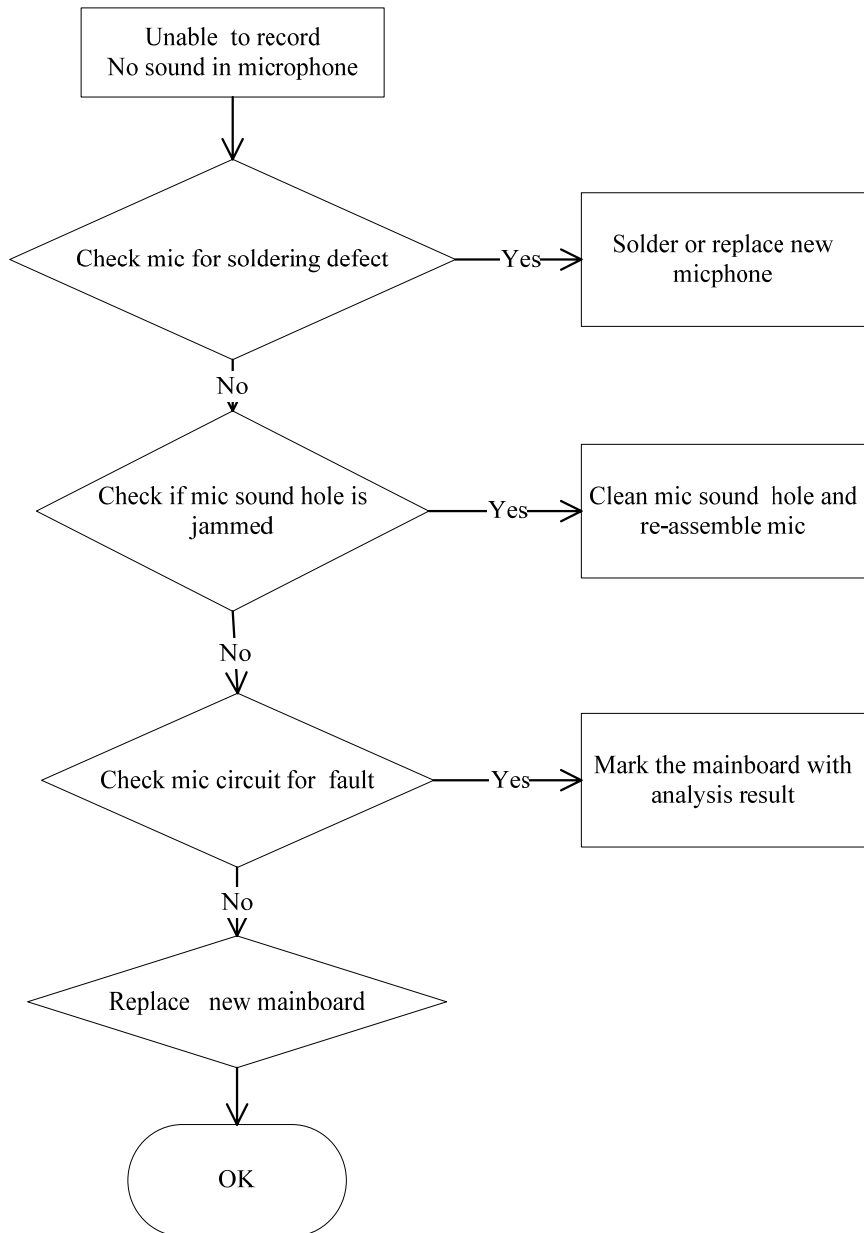

3.8 Keypad fault

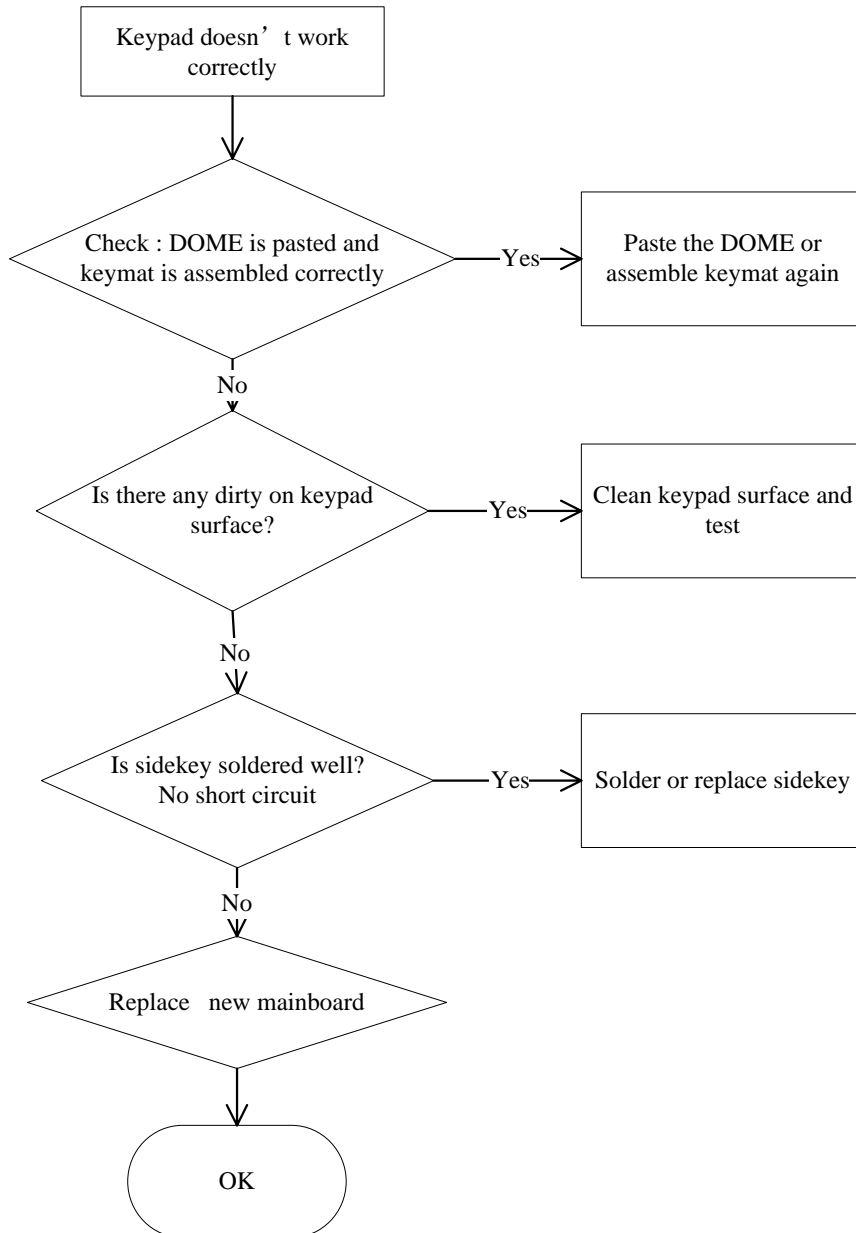

3.9 Receiver fault

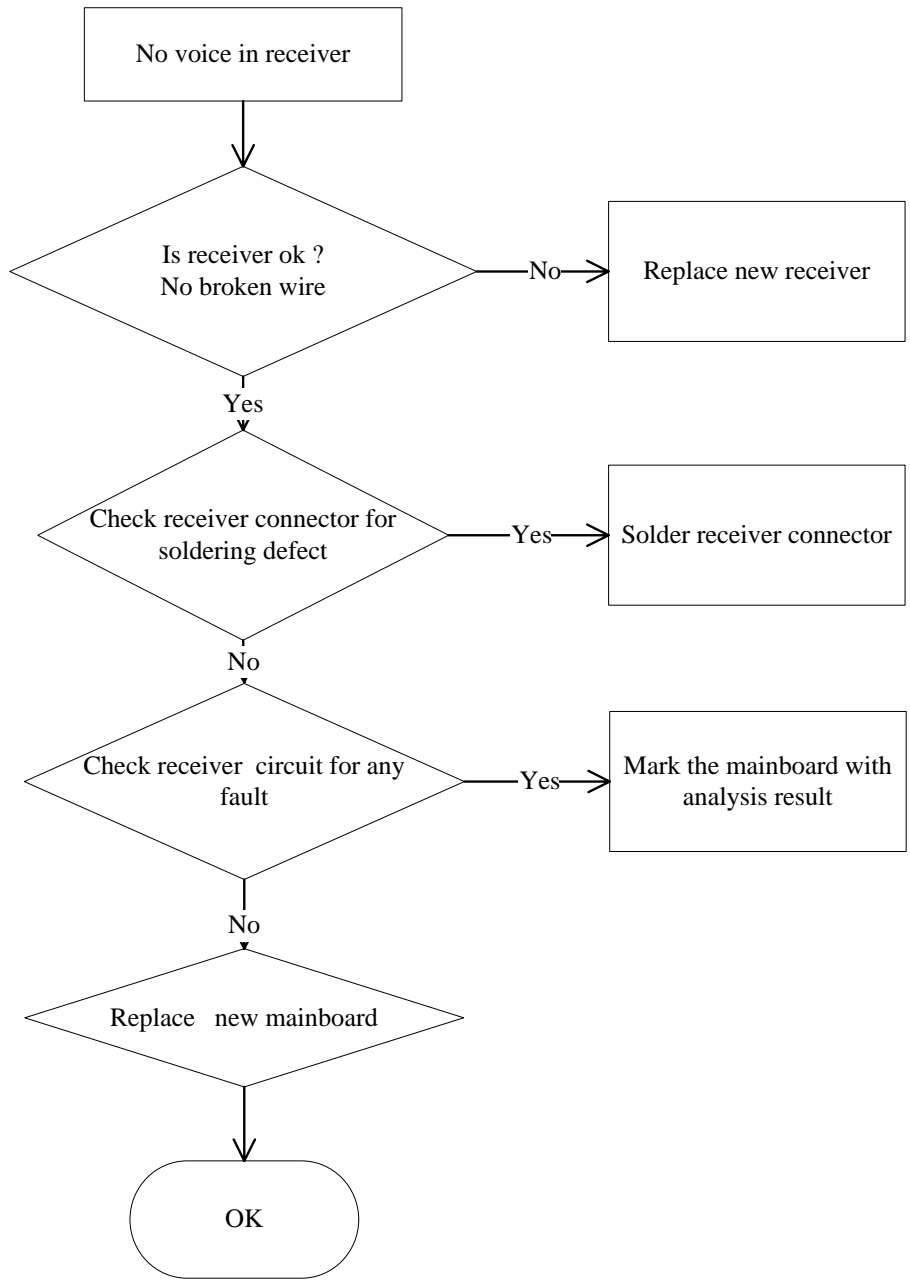

3.10 Vibrate fault

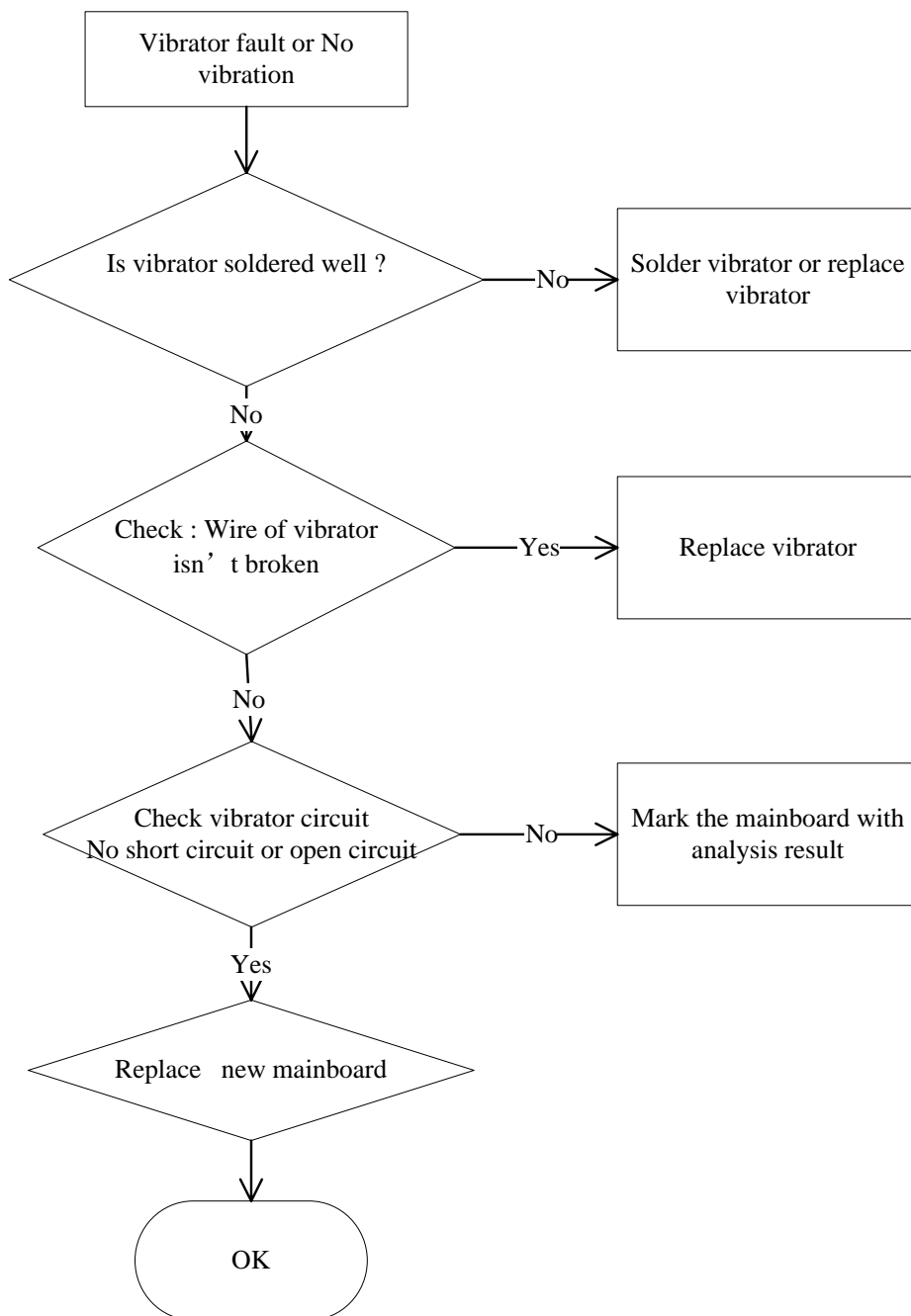

3.11 FM fault

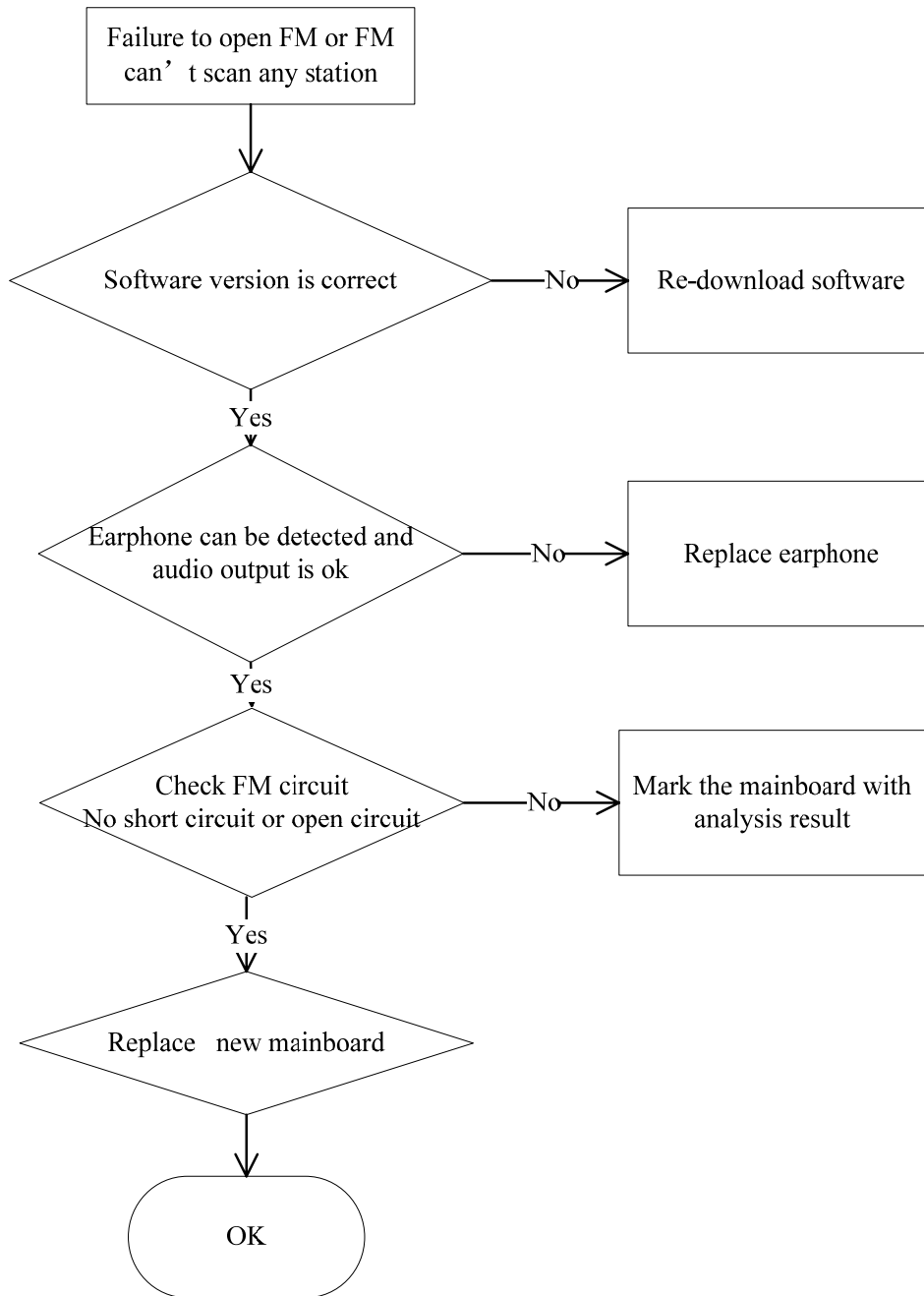

3.12 No signal

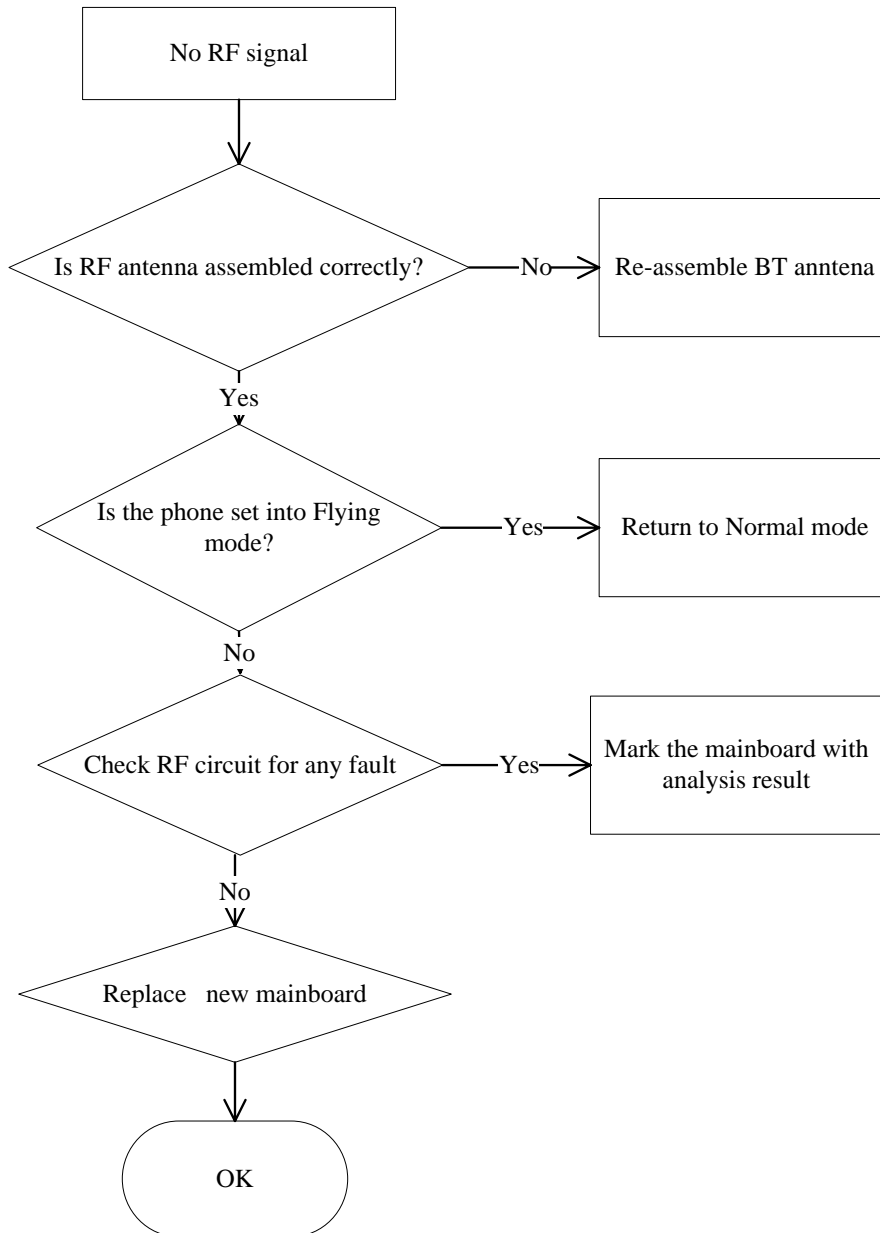

3.13 Failure to identify T-flash card

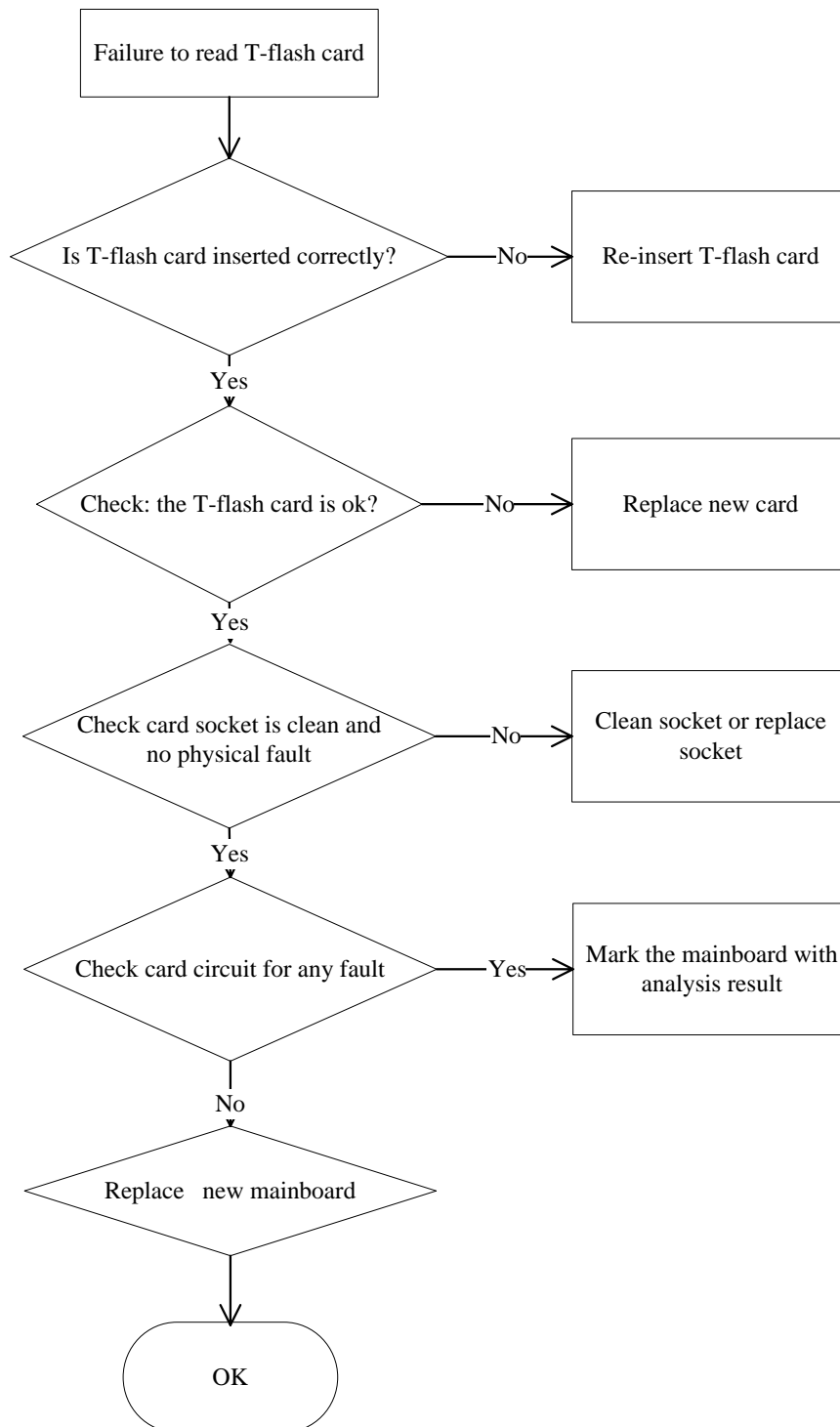

3.14 Earphone fault

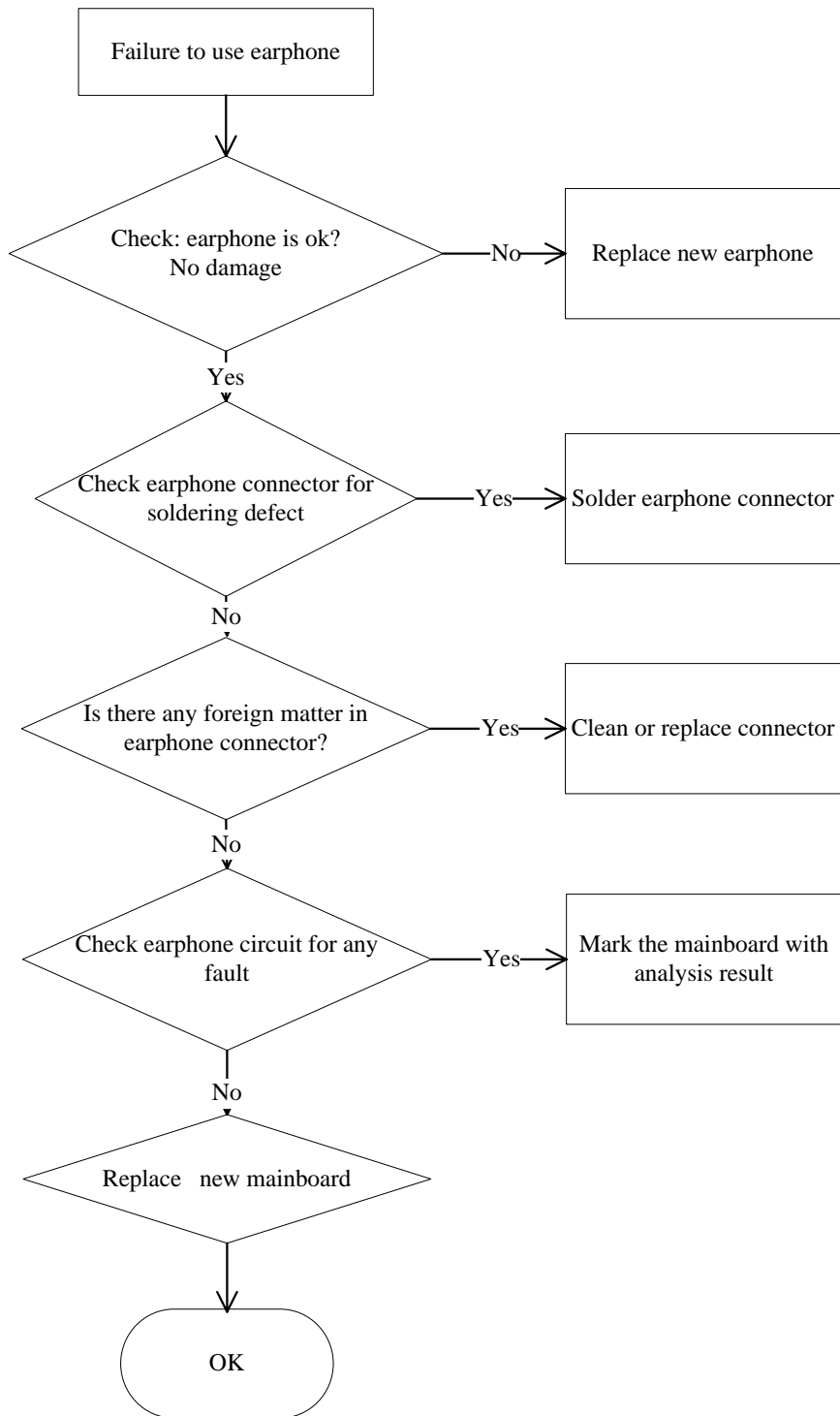

3.15 Unable to use USB

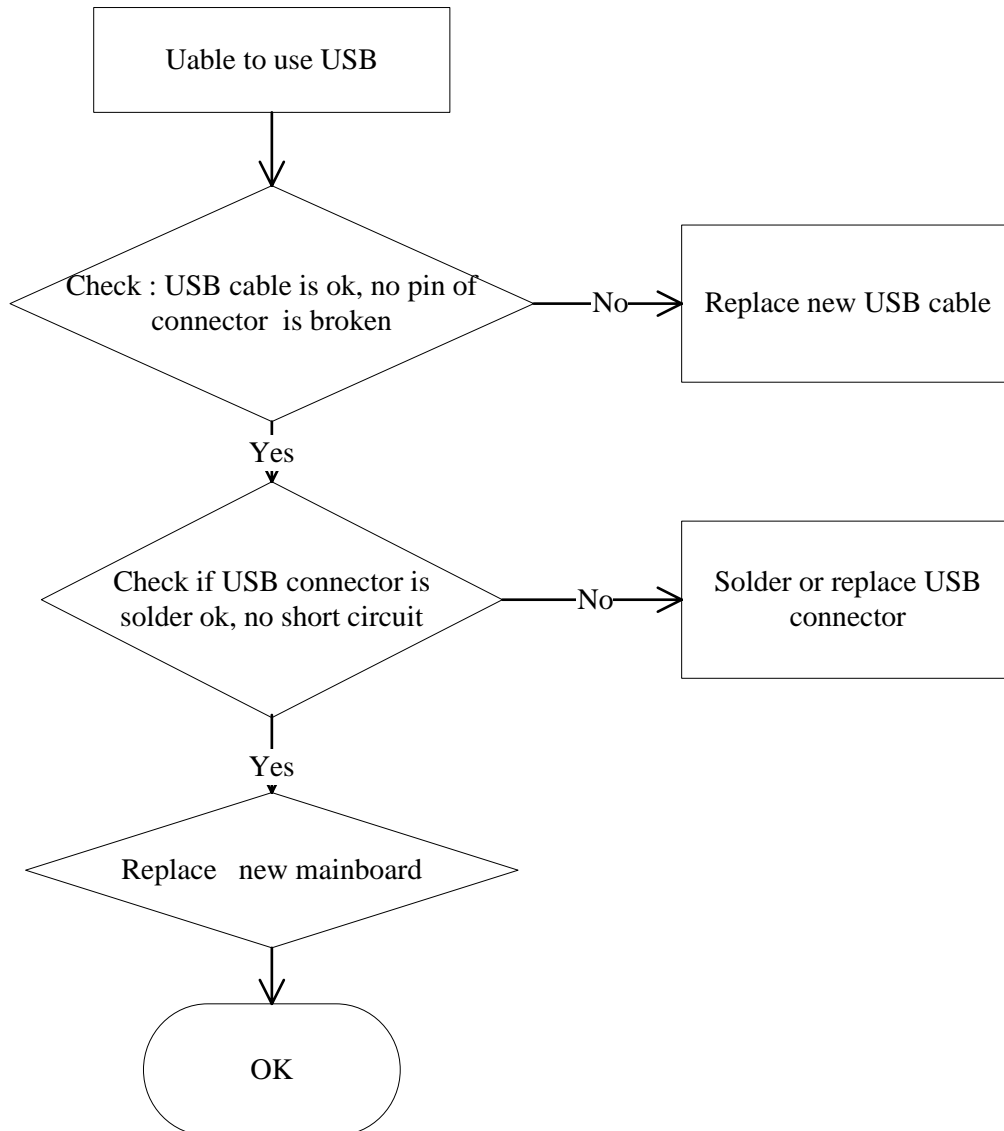

END