

# 11. CIRCUIT DIAGRAMS

## 11.1. Main PCB (Baseband)

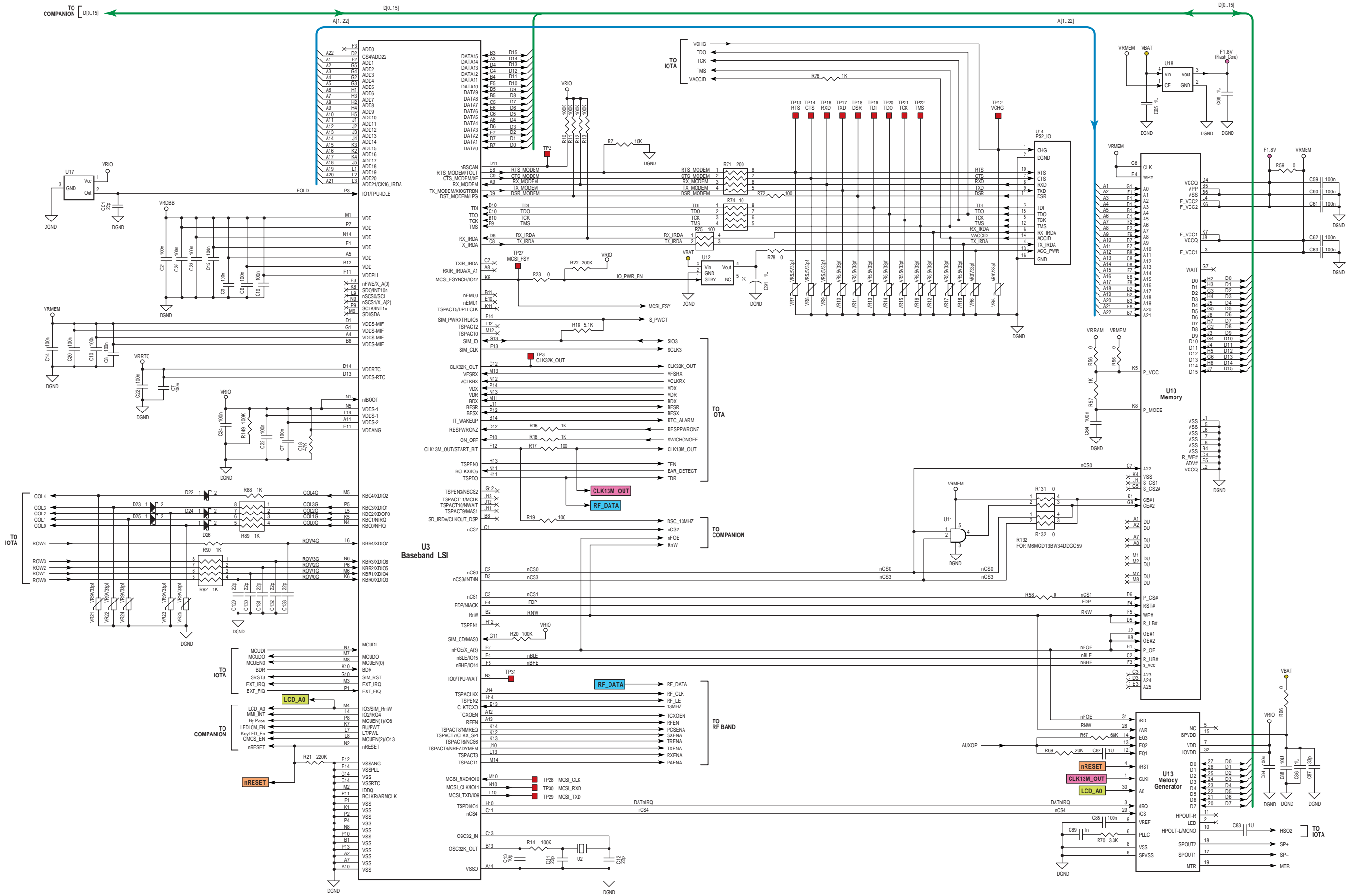

# 11.2. Main PCB (RF Band)

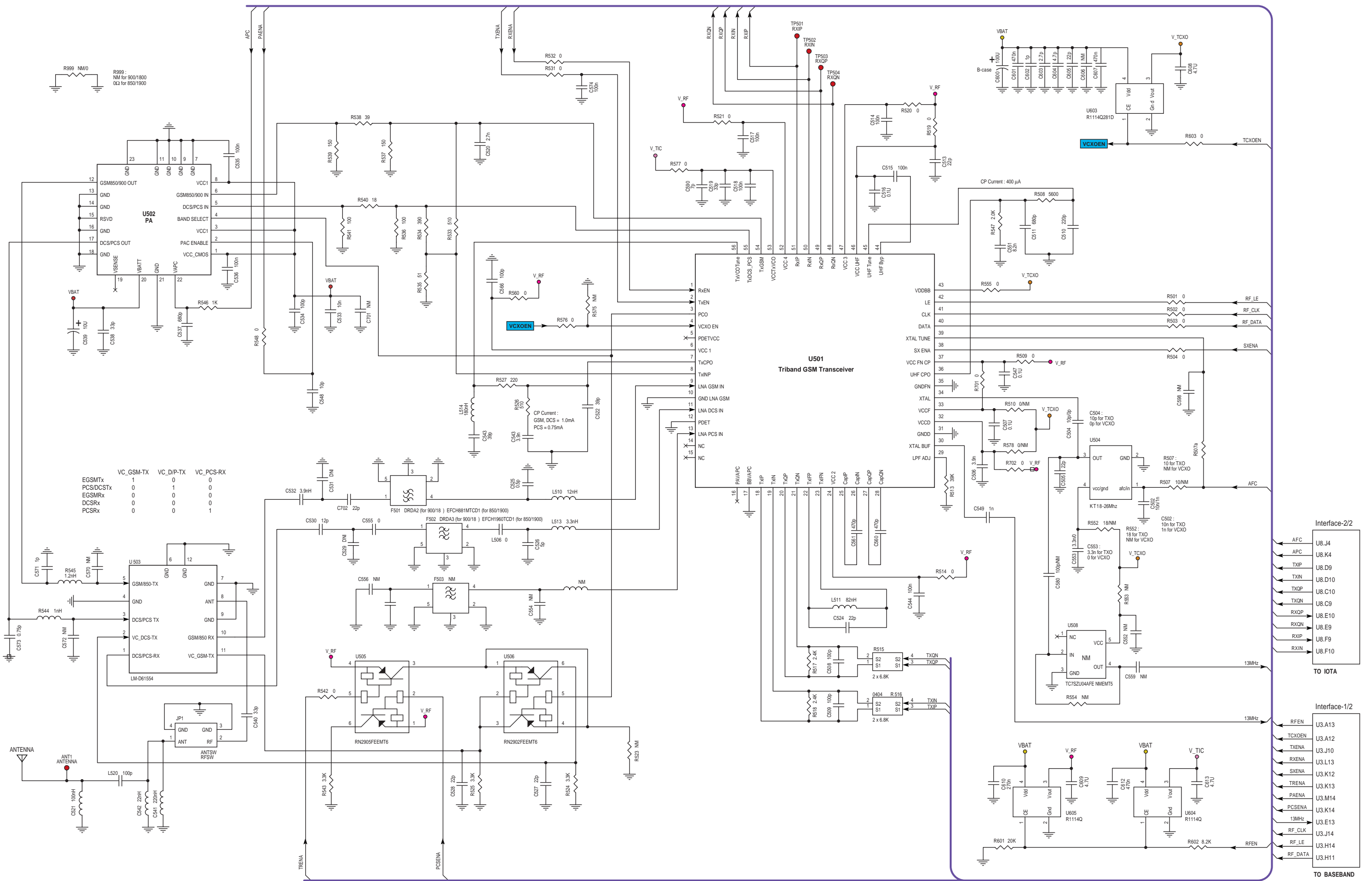

# 11.3. Companion

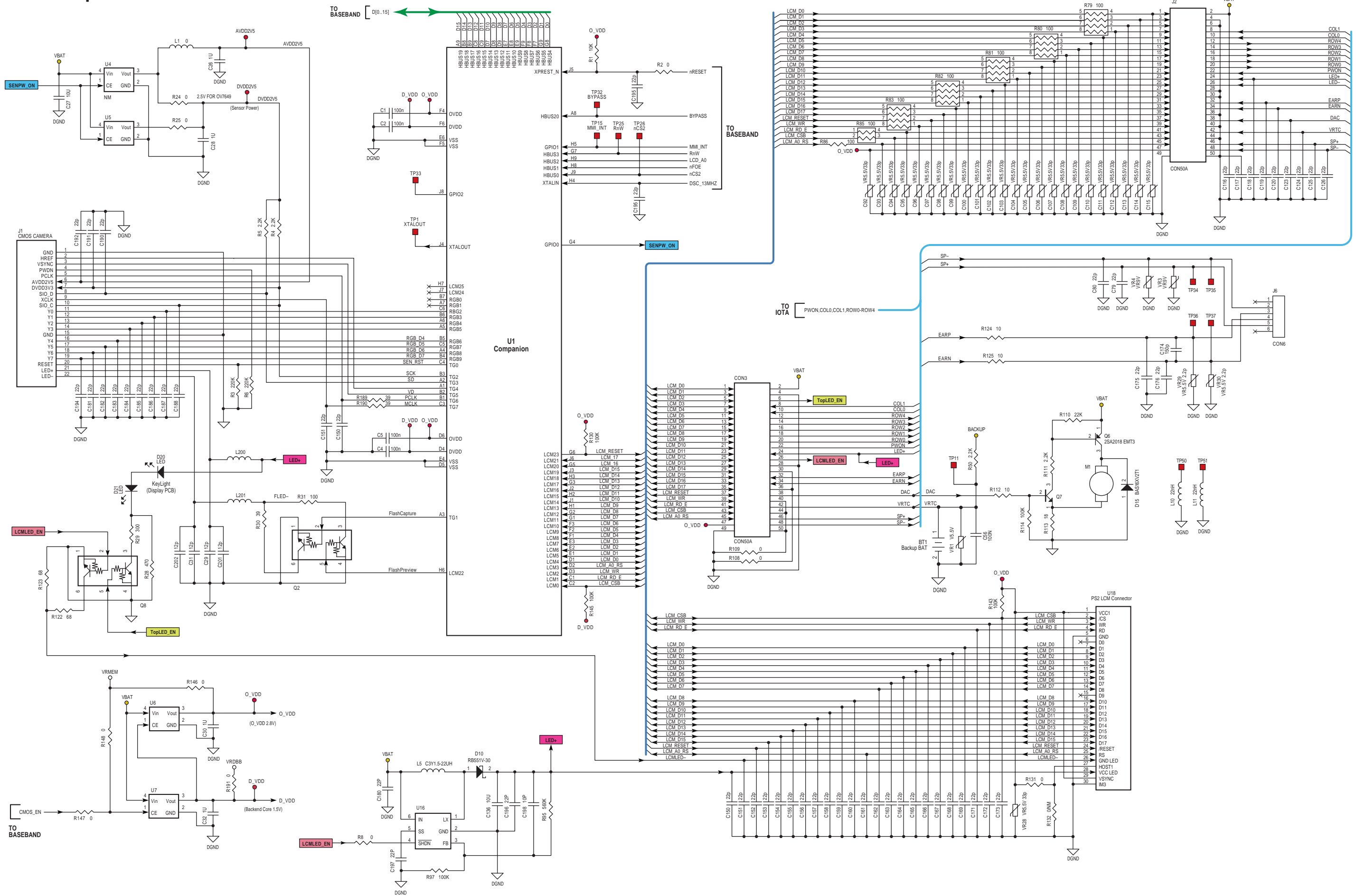

# 11.4. IOTA

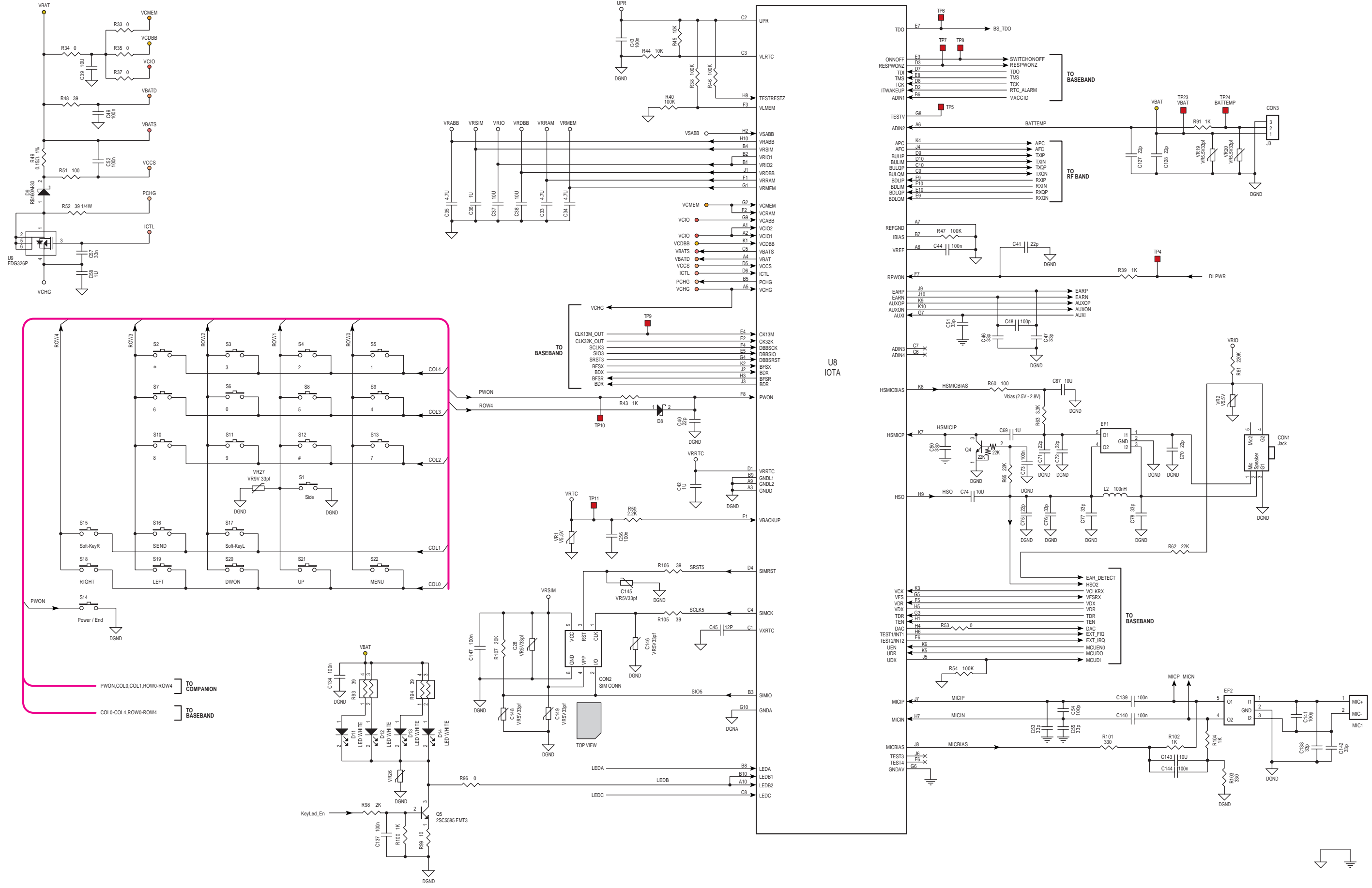

# 12. LAYOUT DIAGRAMS

## 12.1. Main PCB (Top View)

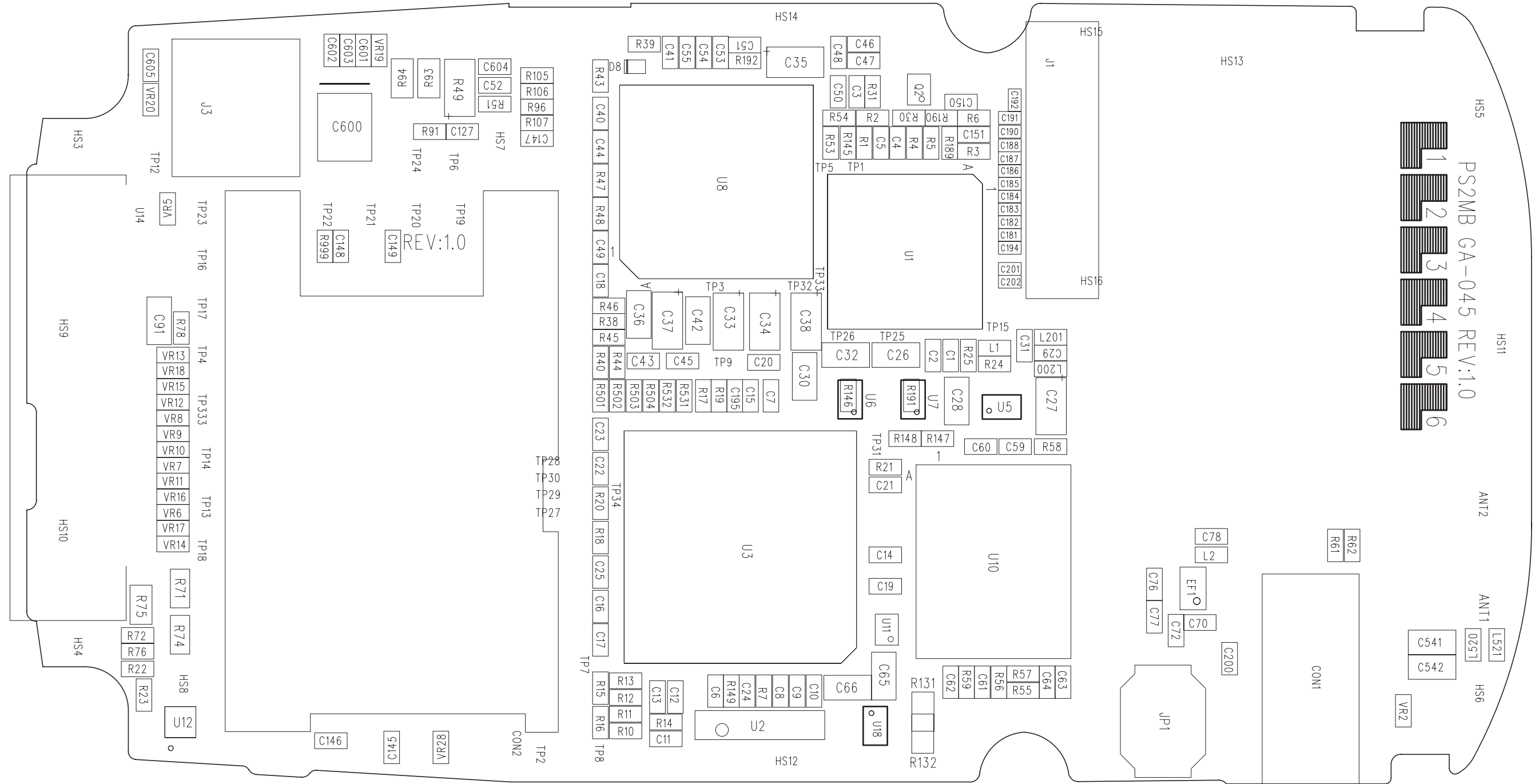

1  
2  
3  
4  
5  
6

PS2MB GA-045 REV:1.0

## 12.2. Main PCB (Bottom View)

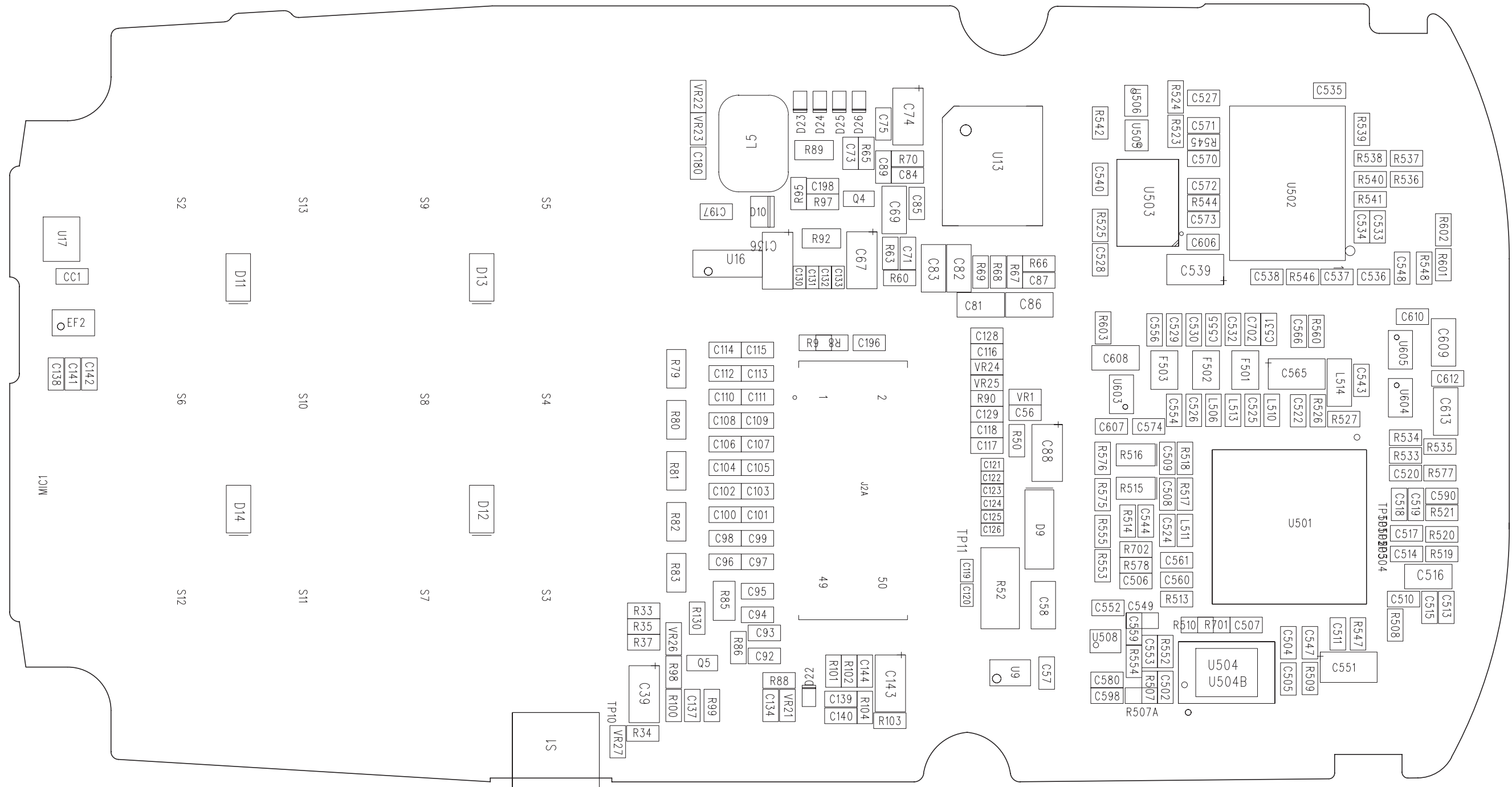

### 12.3. SUB PCB

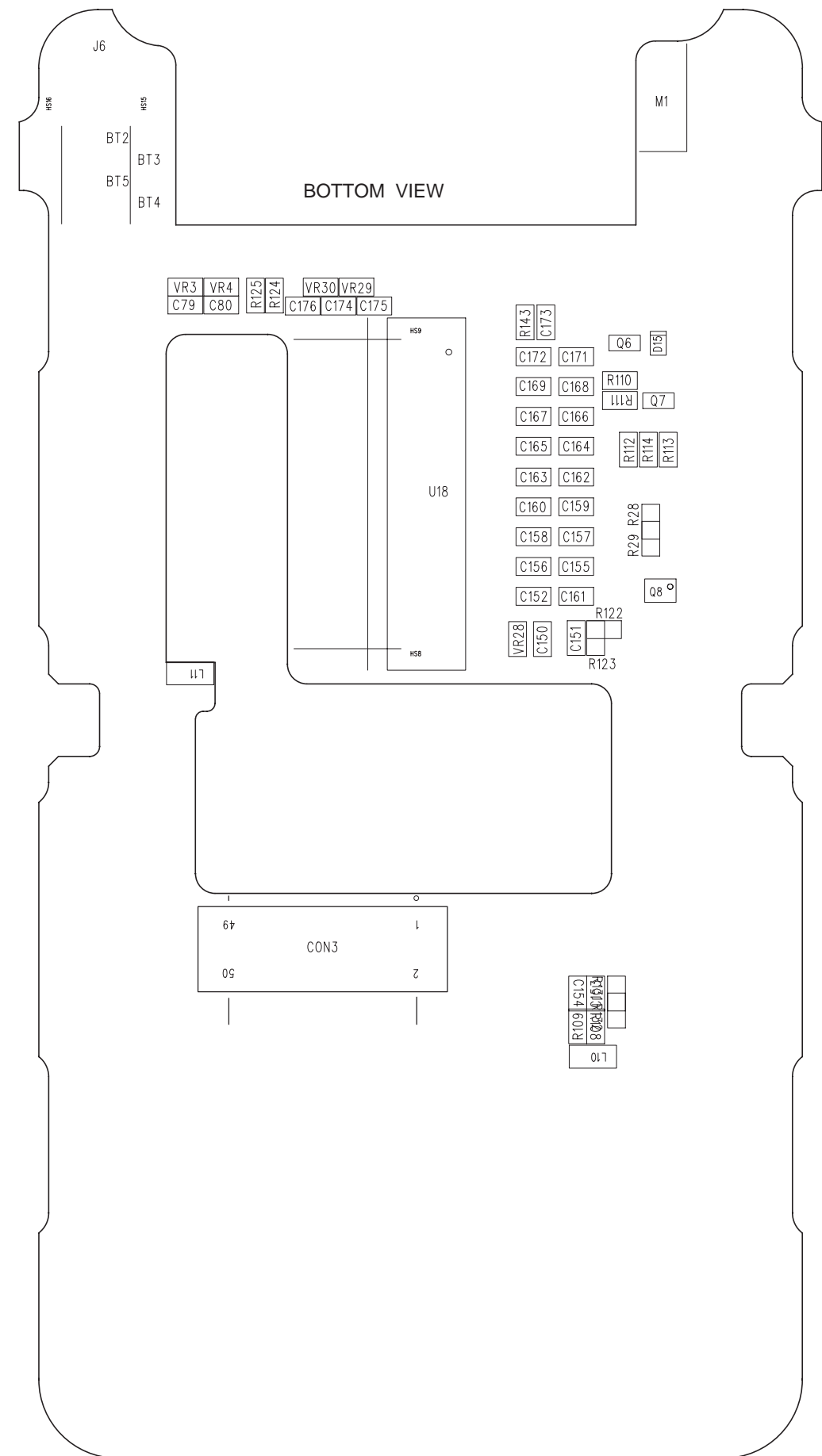
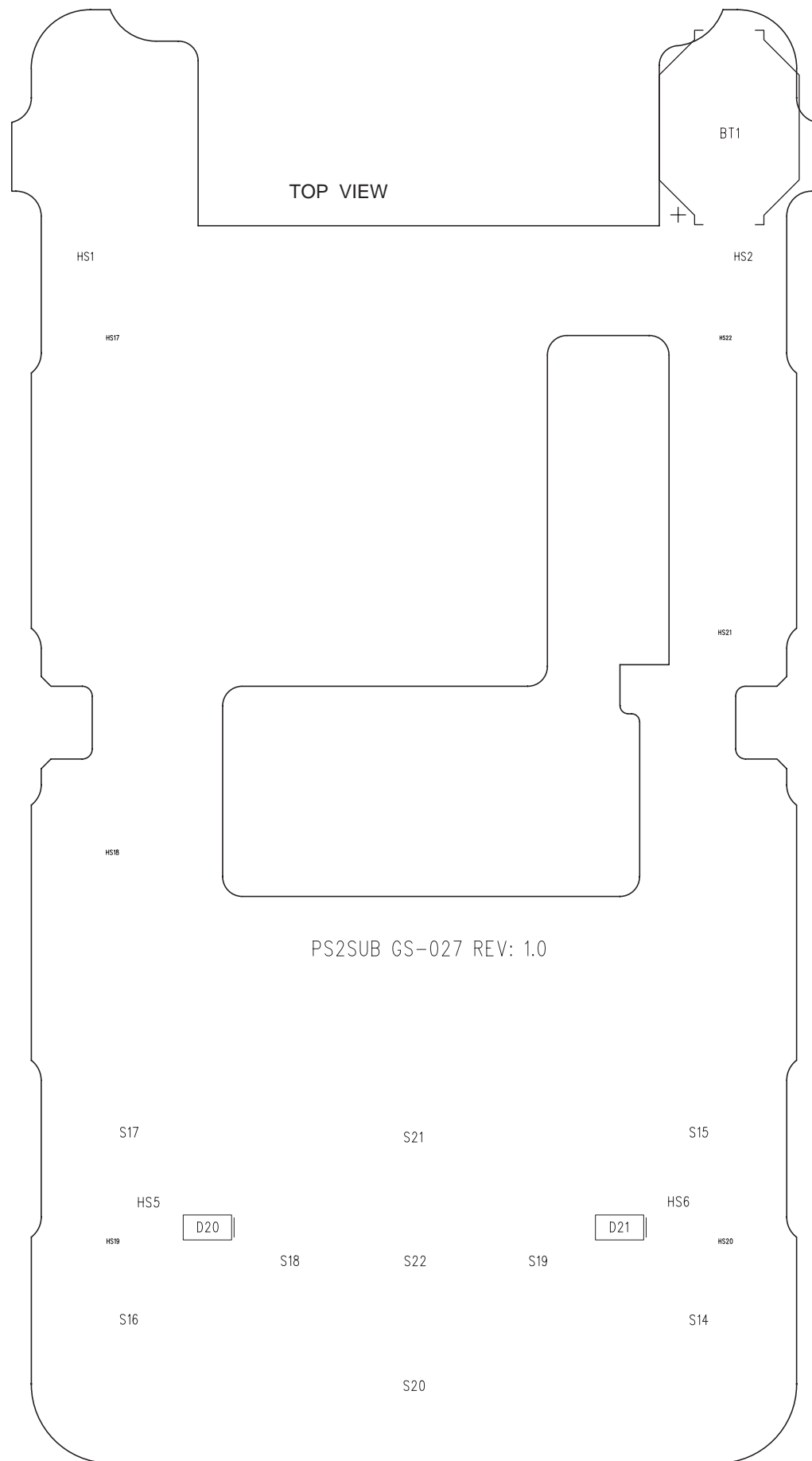



12.4. FB PCB

